

XXXXXXXXXX serie: xxx

 Hergestellt für:

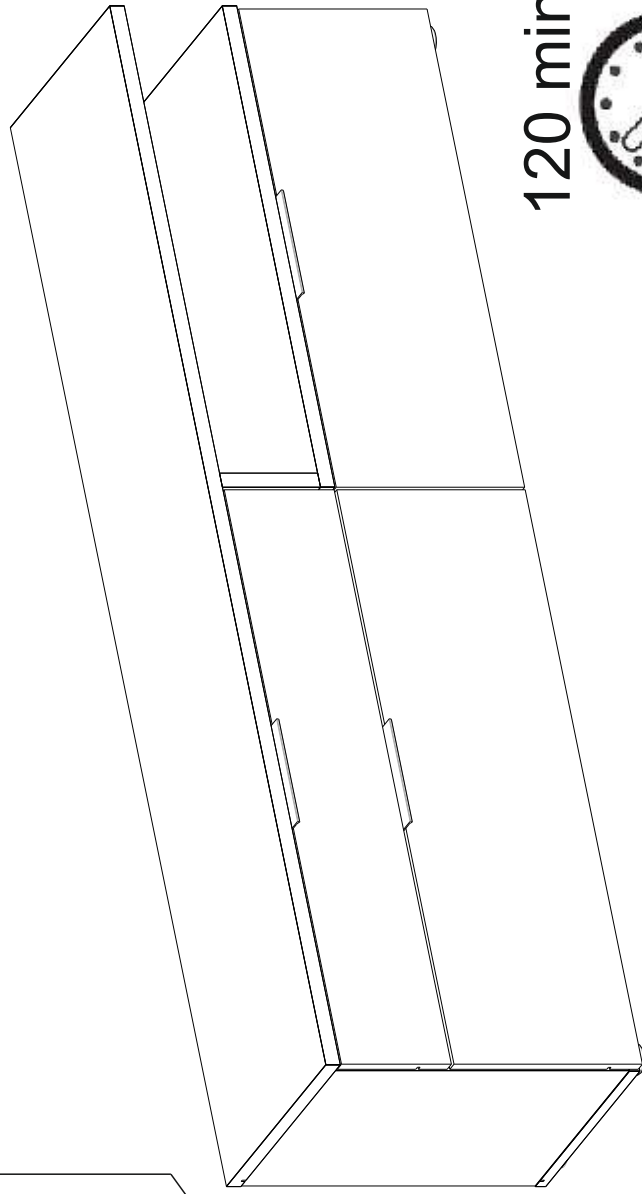

120 min

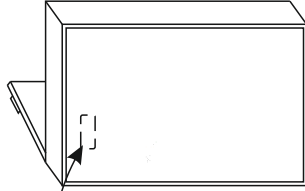
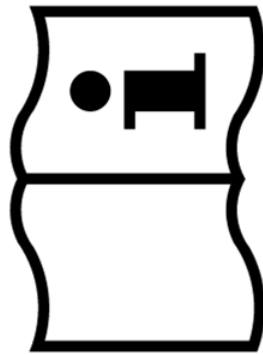

- Correct handling of panels (smiley face) vs. incorrect handling (sad face).
 - Eye protection (eye icon with arrows).
 - No eating or drinking (person eating/drinking with a slash).
 - 100% COTTON gloves (gloves with cotton icon).
 - No smoking (cigarette with a slash).
 - Correct lifting technique (two people lifting correctly vs. incorrectly).
 - Tools: screwdriver, hammer, pencil, utility knife, hole saw (Ø8), and drill.

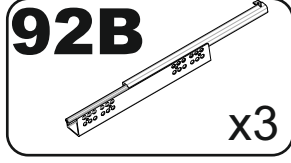
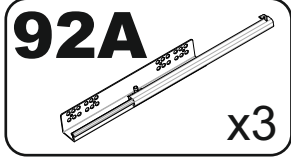
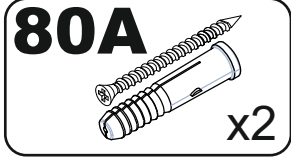
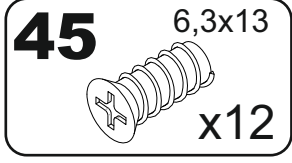
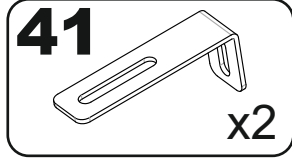
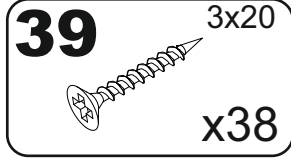
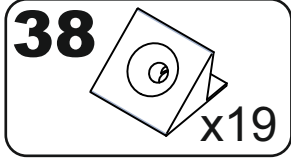
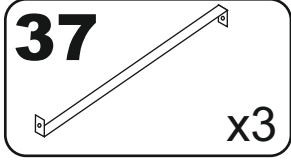
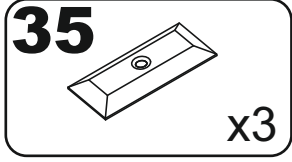
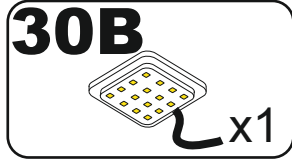
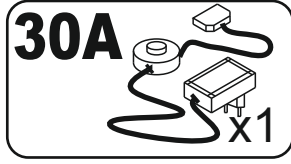
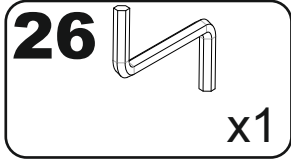
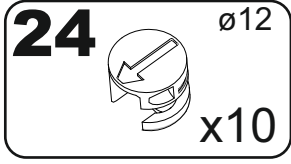
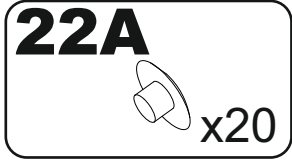
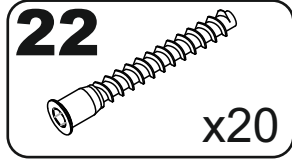
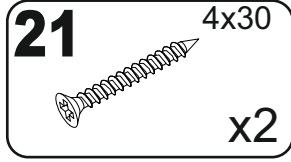
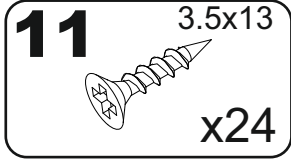
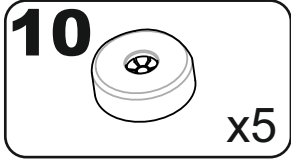
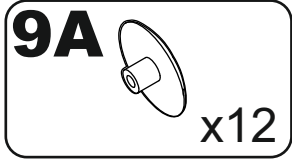
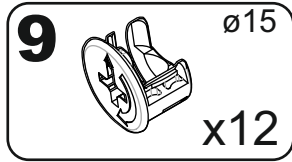
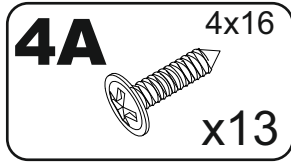
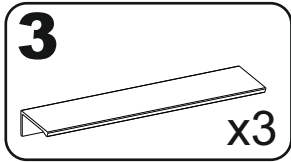
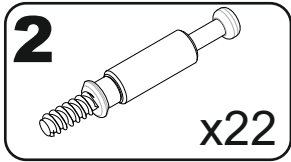
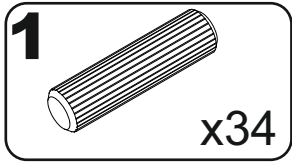
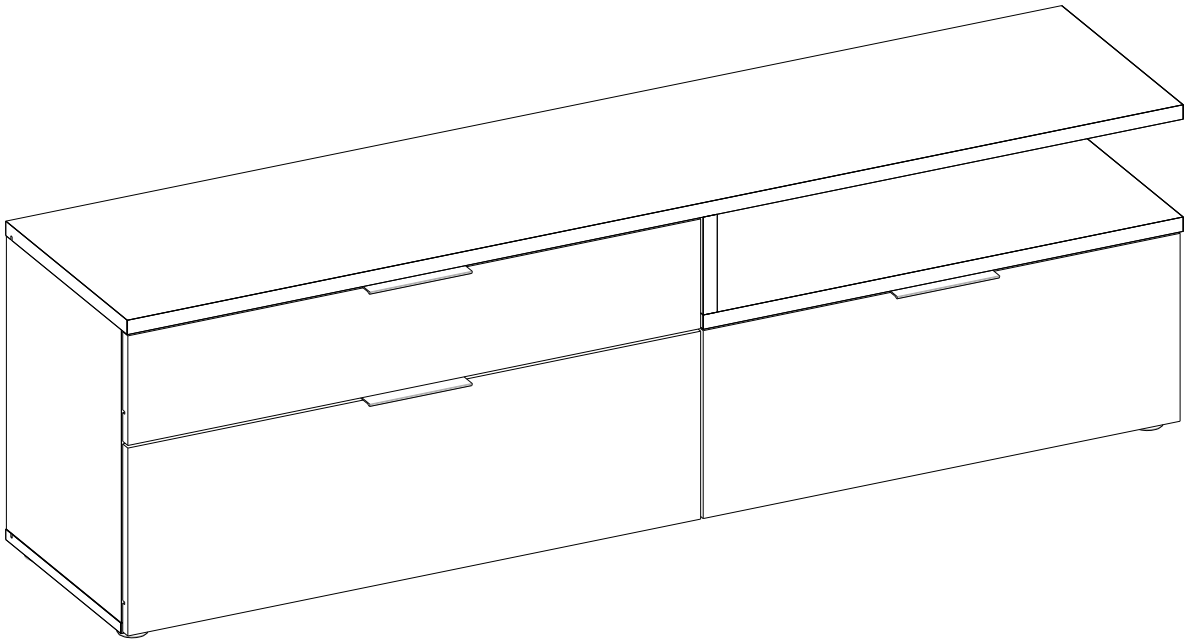
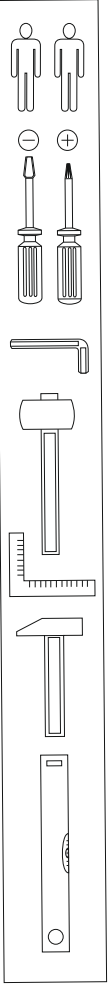

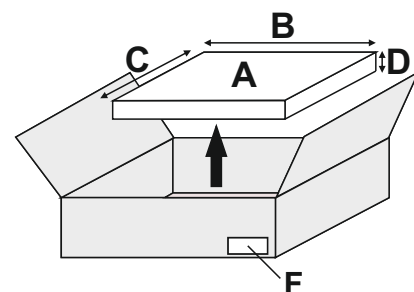
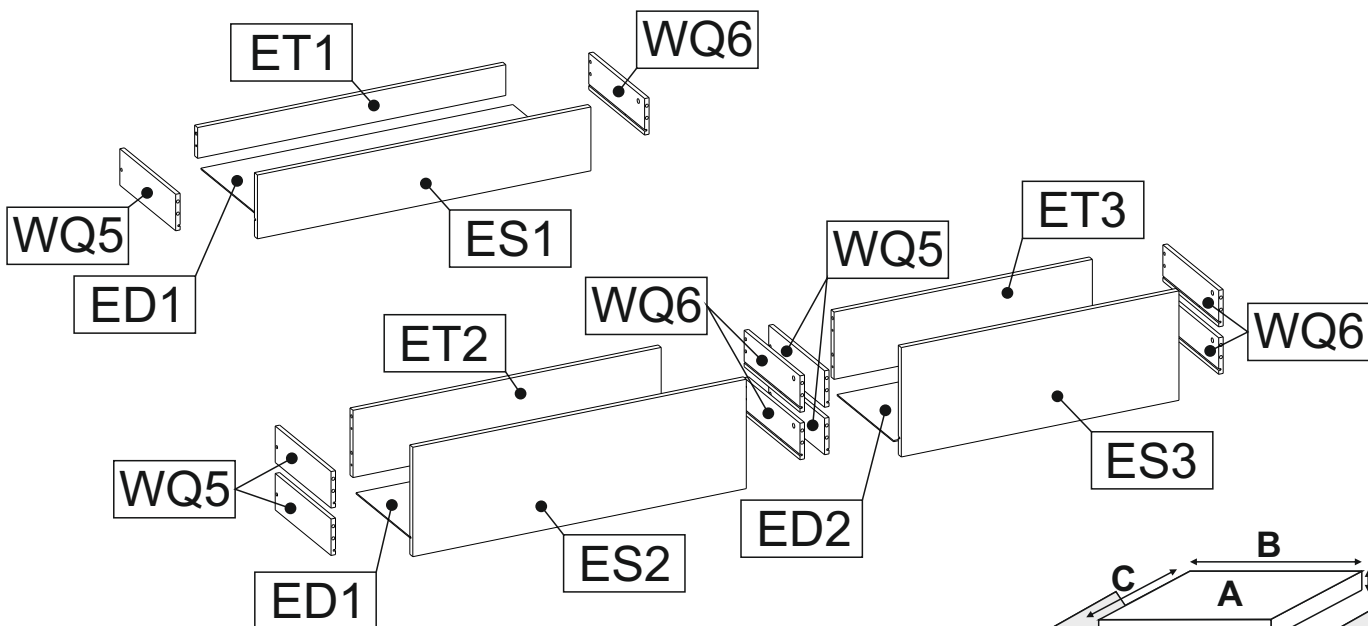
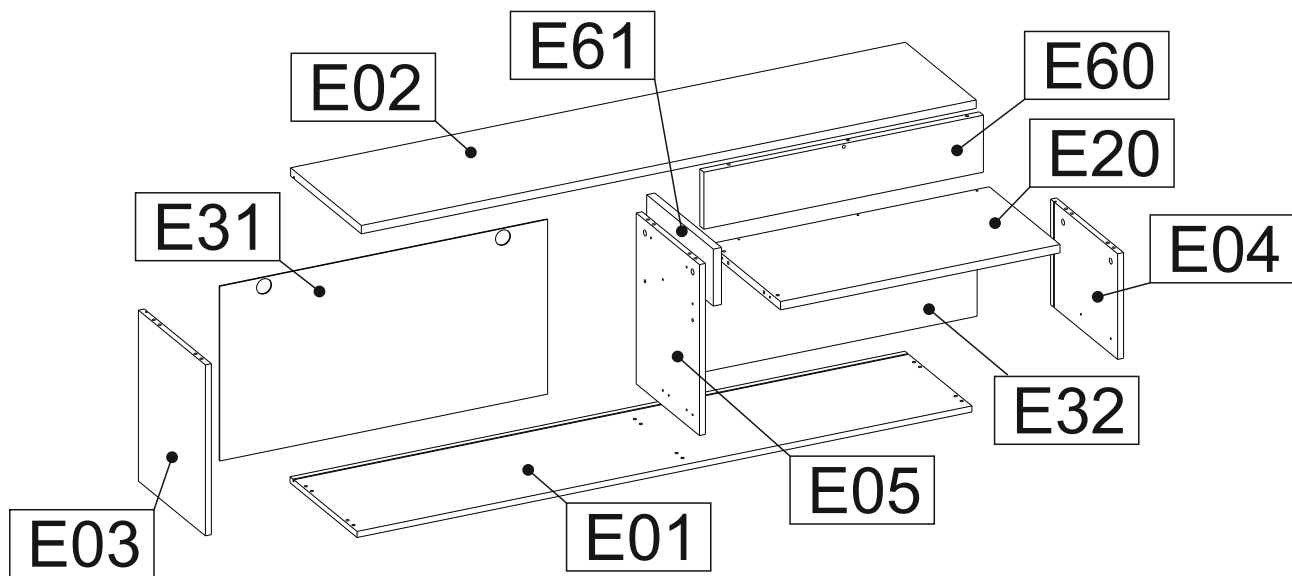

A	B_(m m)	C_(m m)	D_(m m)	E	F
E01	1652	360	16	1	2 2
E02	1652	380	22	1	2 2
E03	450	360	16	1	2 2
E04	278	360	16	1	2 2
E05	450	340	16	1	2 2
E20	751	380	22	1	2 2
E31	881	460	3	1	1 2
E32	747	288	3	1	1 2
E60	751	150	22	1	2 2
E61	150	358	22	1	2 2
ED1	838	303	3	2	1 2
ED2	704	303	3	1	1 2
ES1	896	168	16	1	1 2
ES2	896	288	16	1	1 2
ES3	746	288	16	1	1 2
ET1	828	81	16	1	1 2
ET2	828	177	16	1	1 2
ET3	694	177	16	1	1 2
W Q 5	300	96	12	5	1 2
W Q 6	300	96	12	5	1 2

1

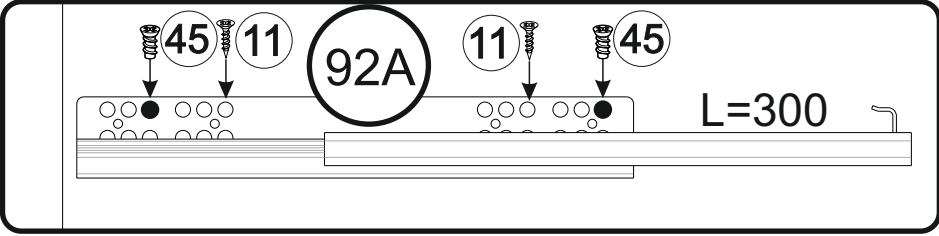
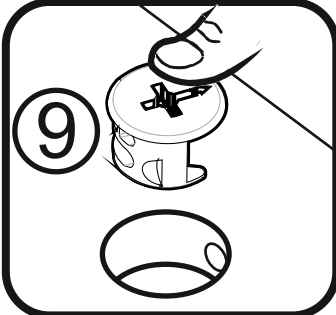
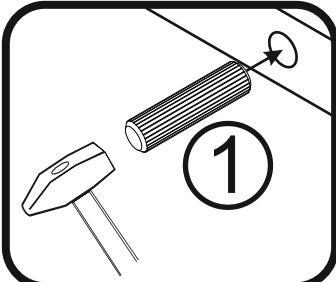
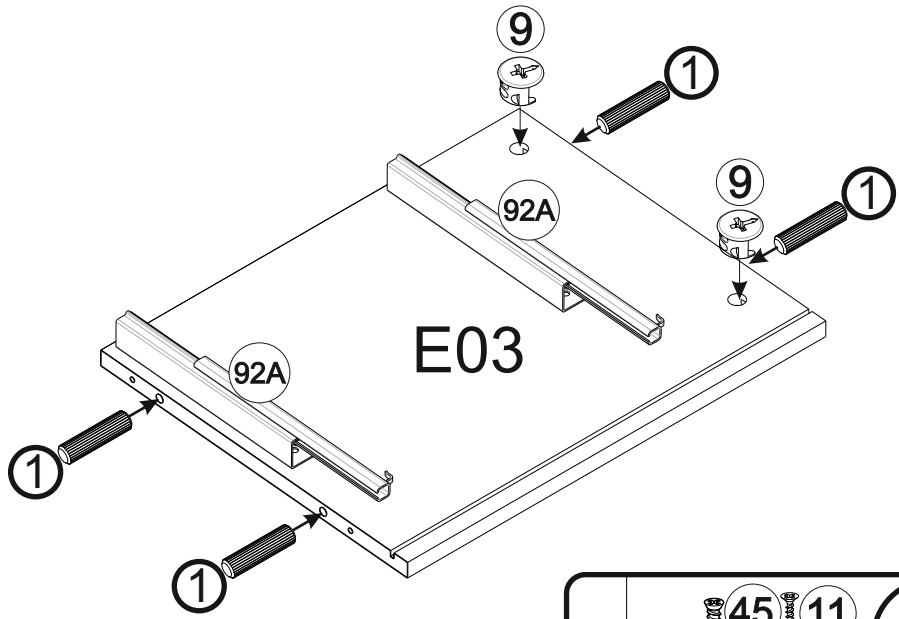
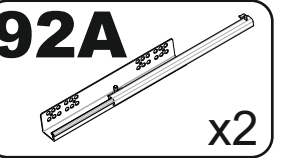
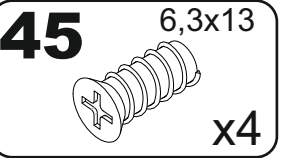
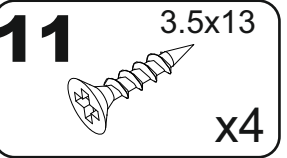
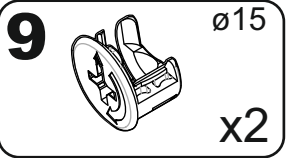
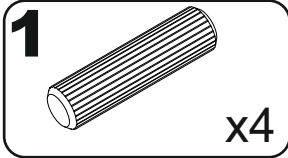

2

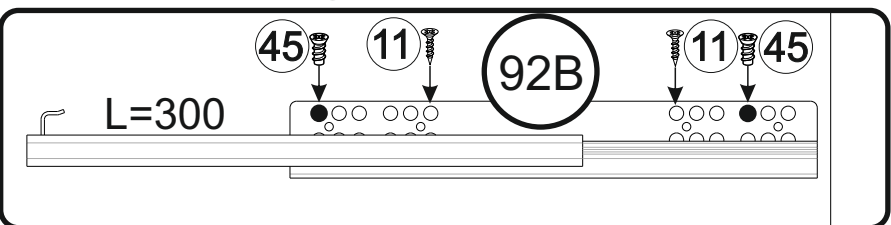
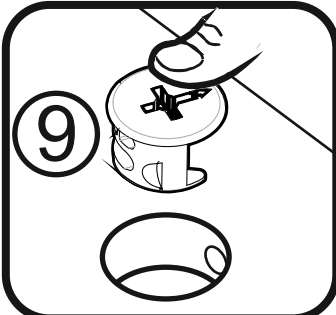
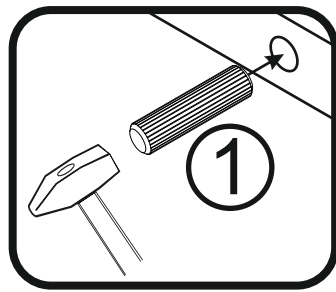
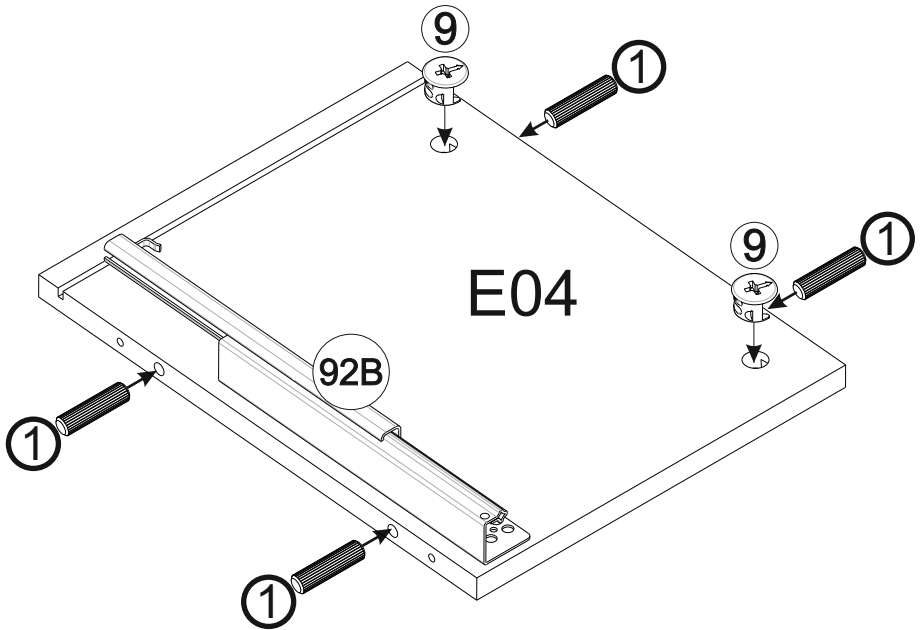
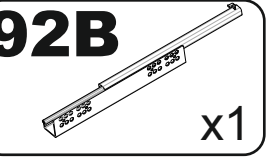
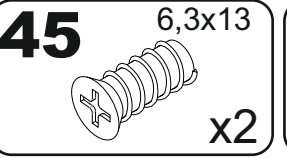
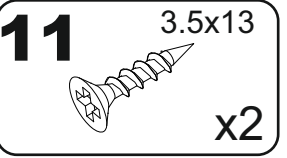
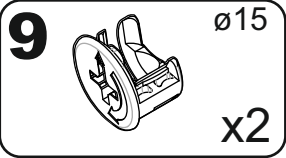
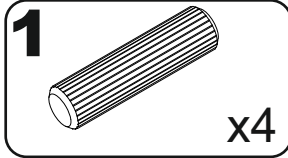

3

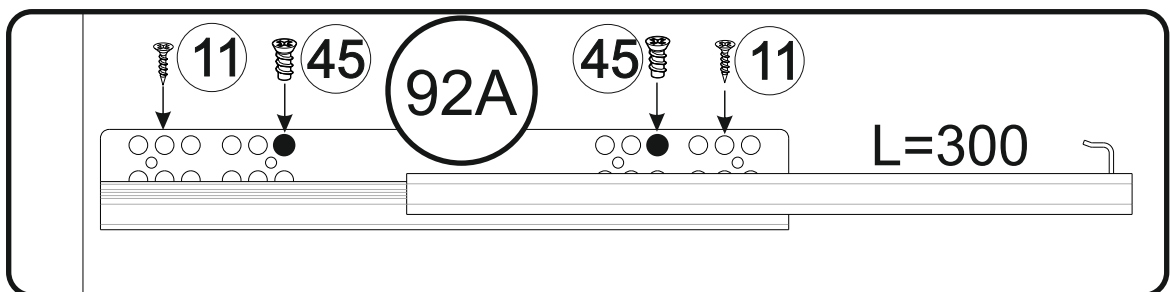
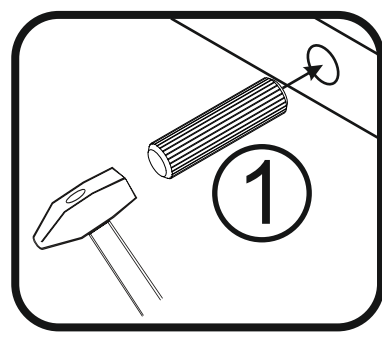
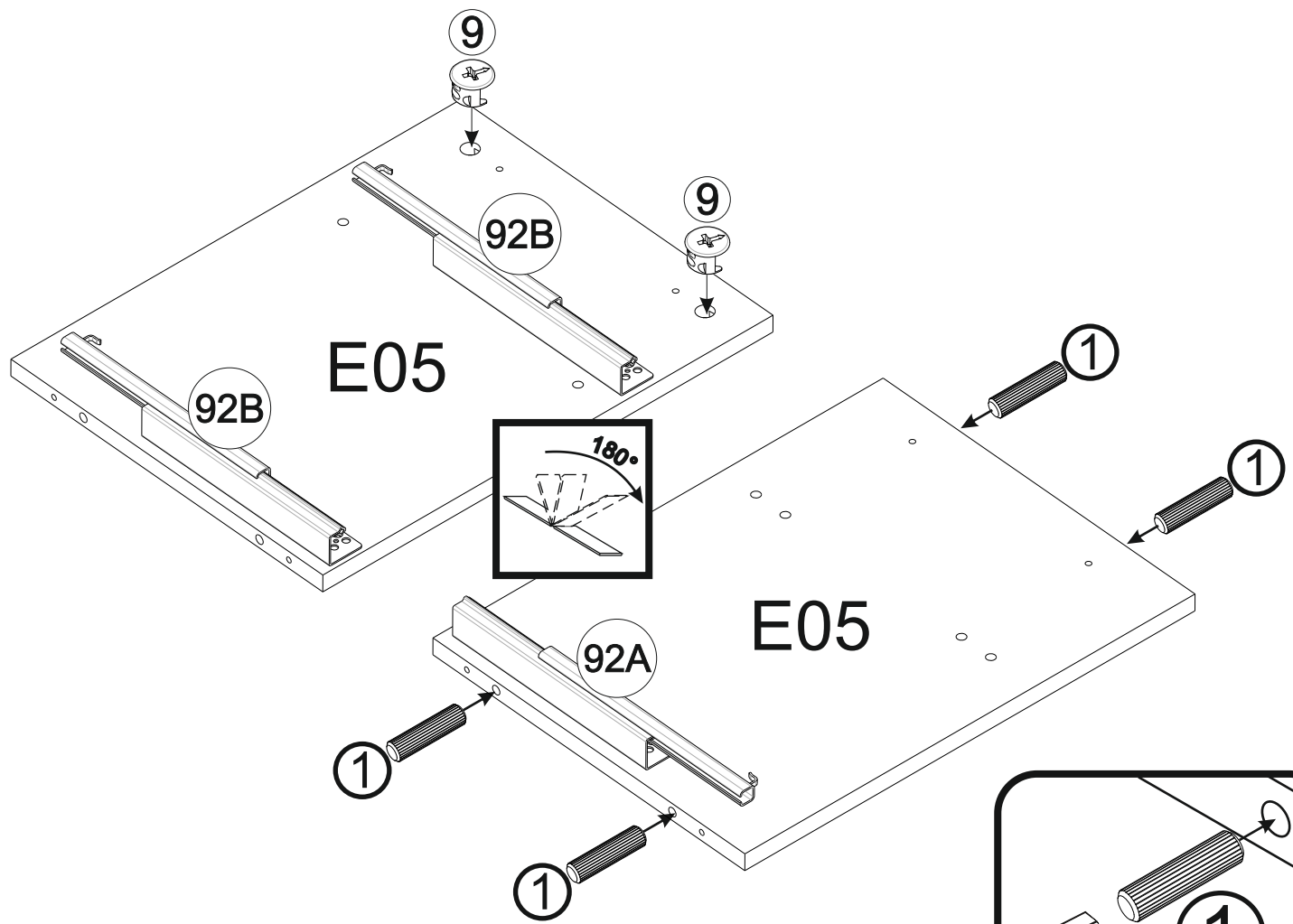
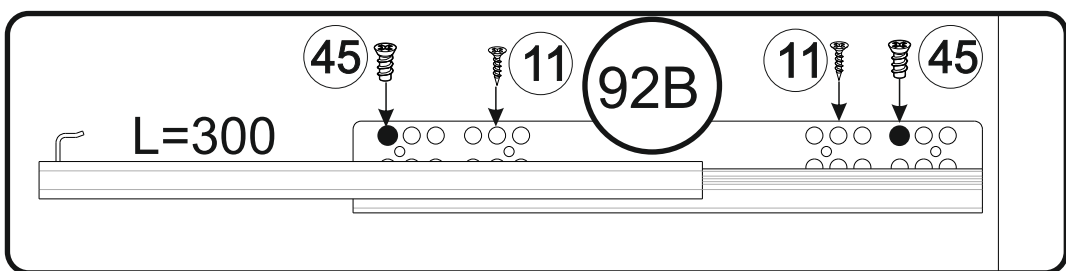
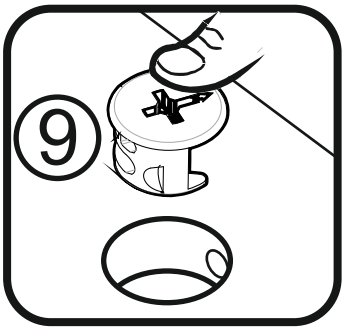
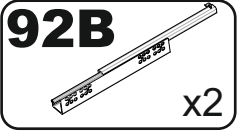
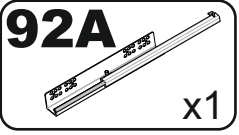
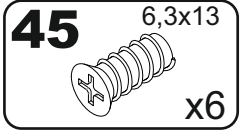
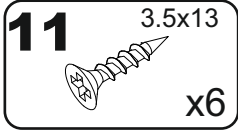
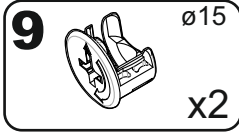
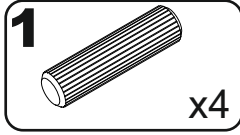

4

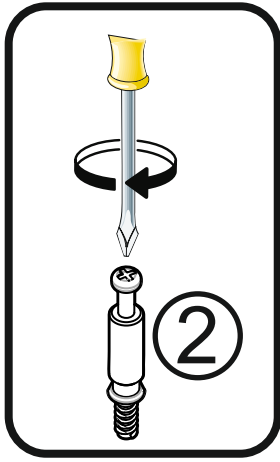
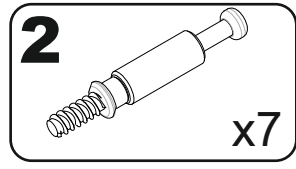
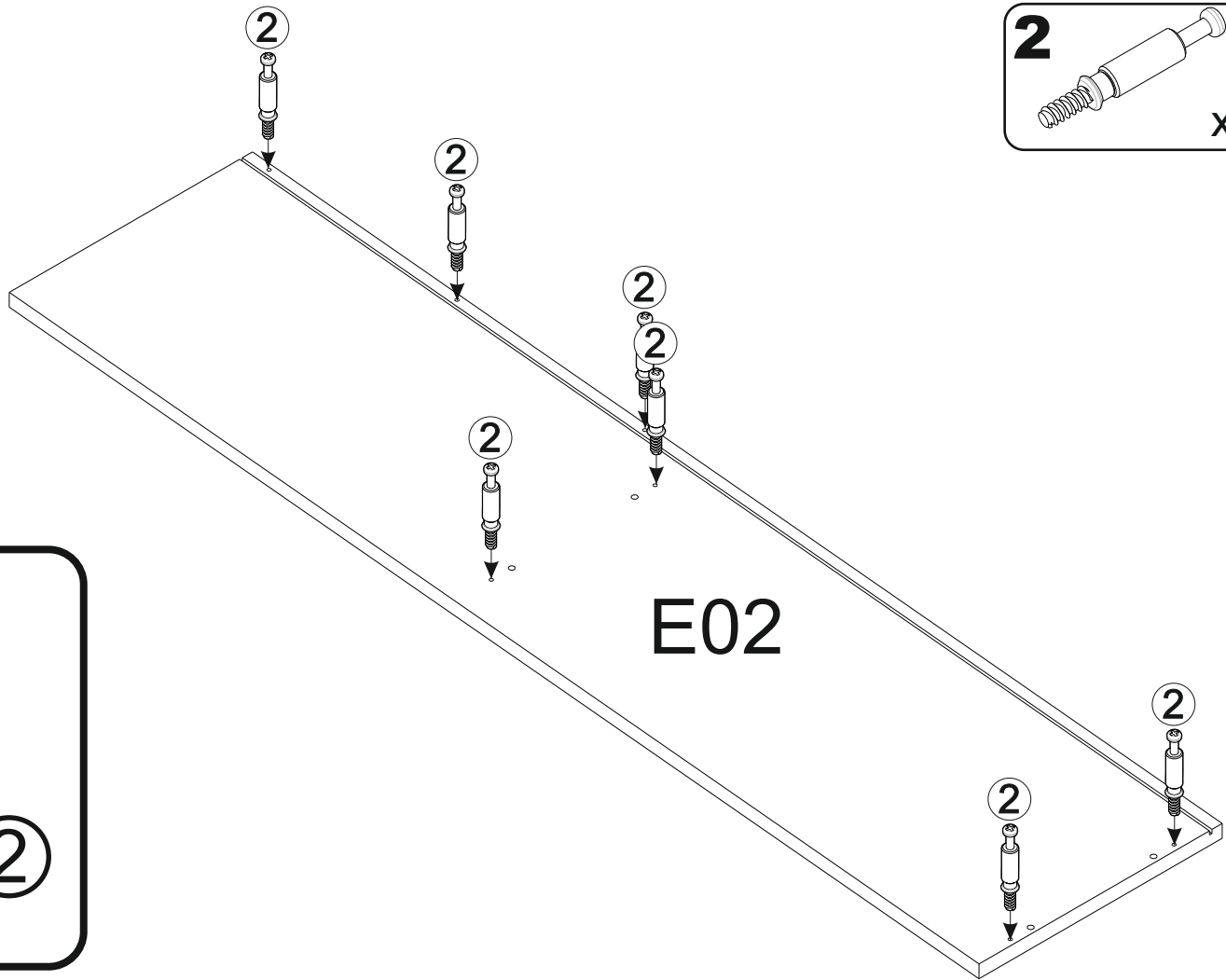

5

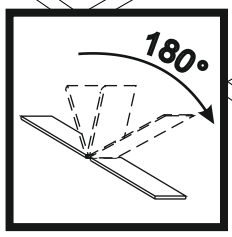
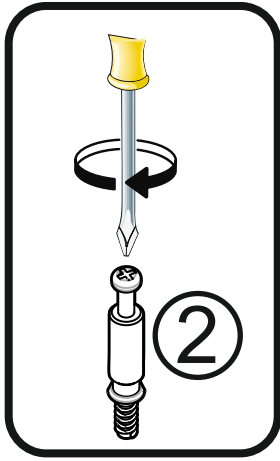
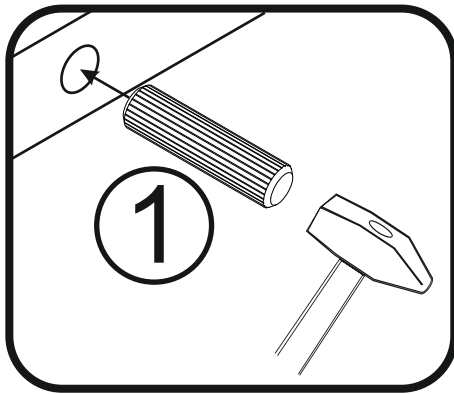
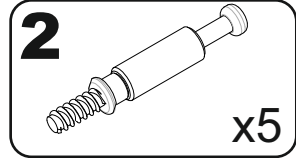
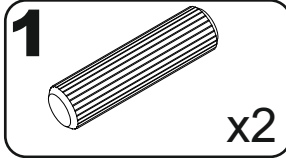
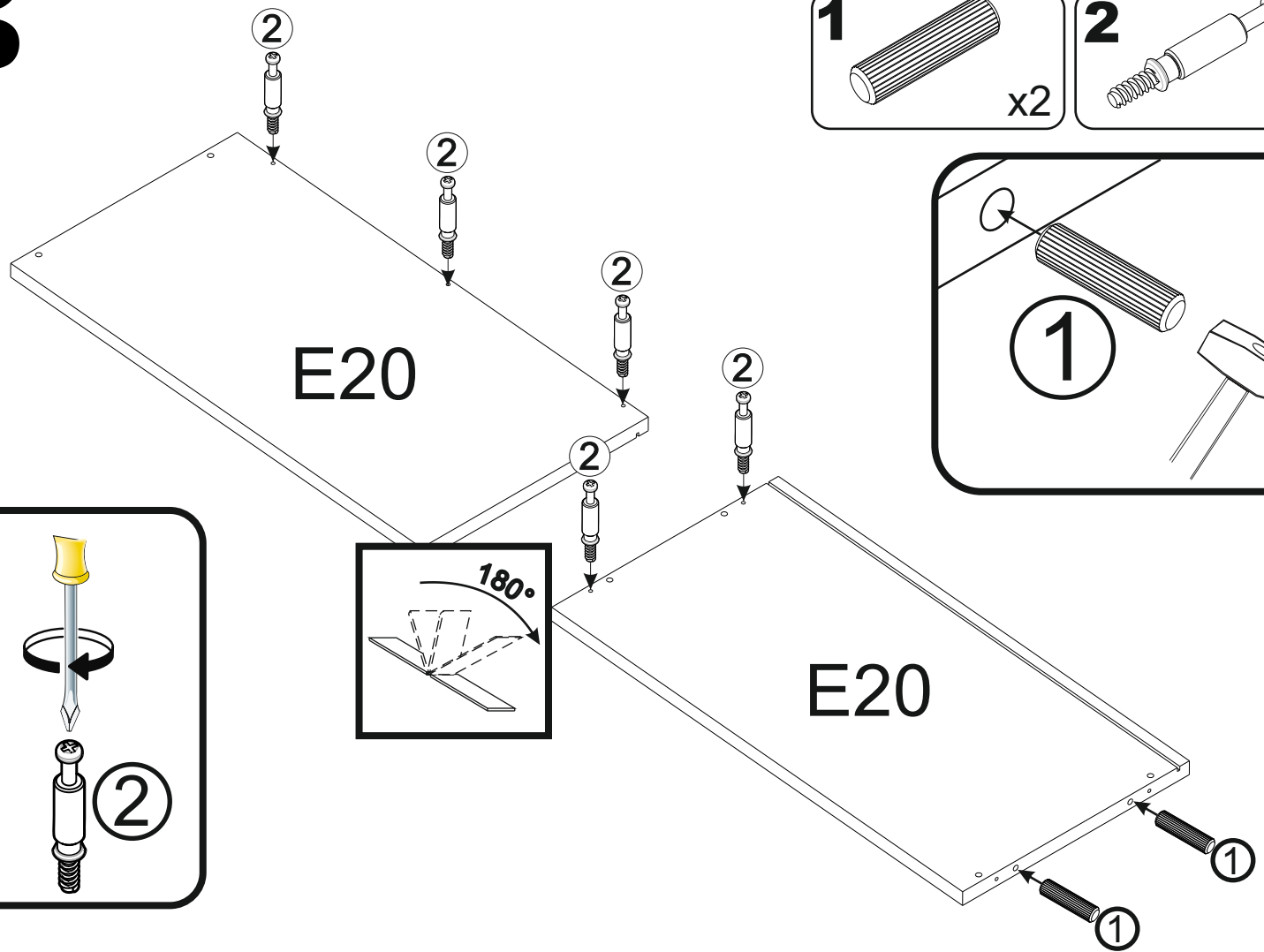

6

6

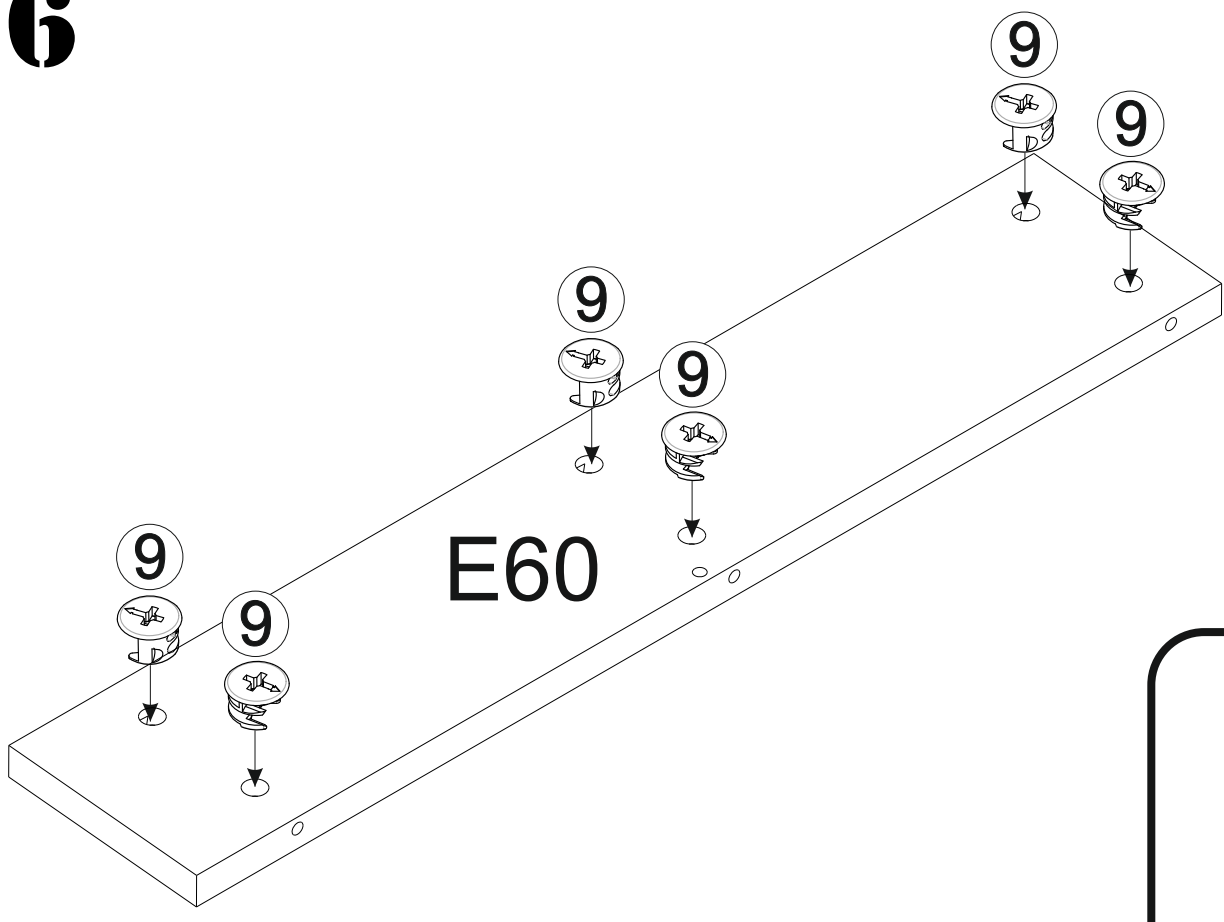

9 $\varnothing 15$
x6

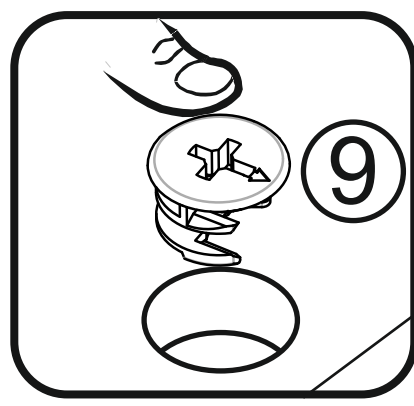

7

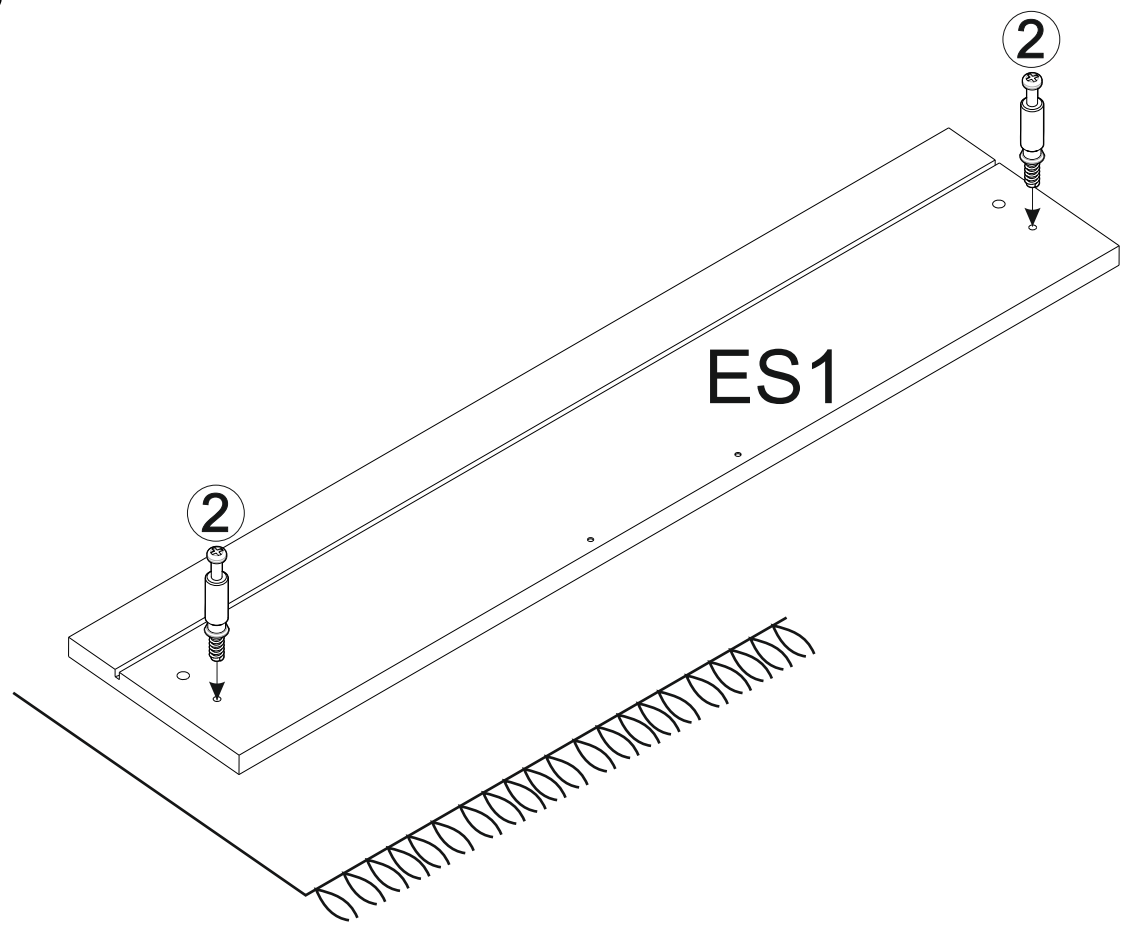

2 x2

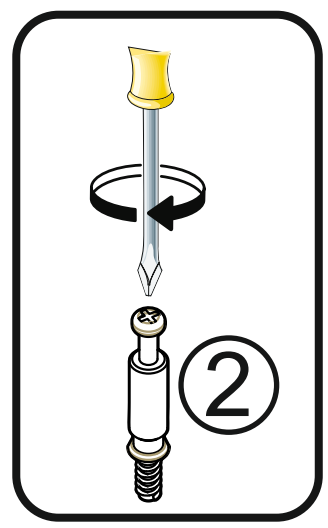

8

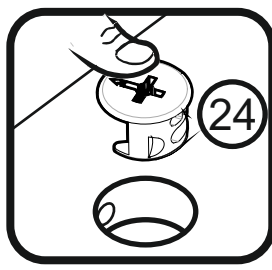
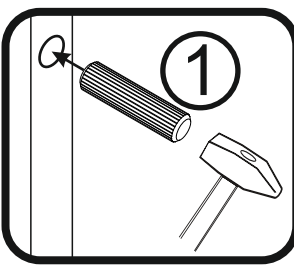
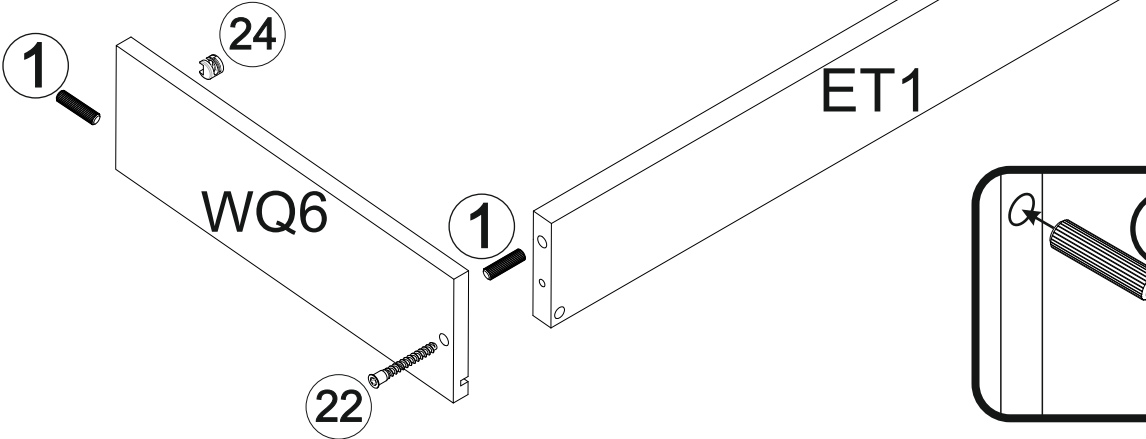
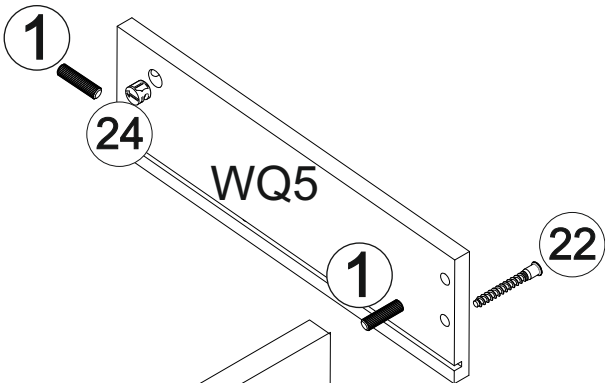
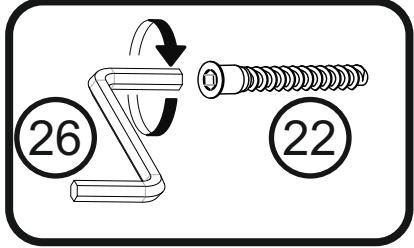
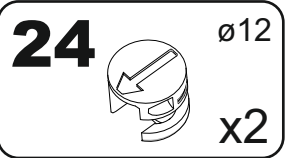
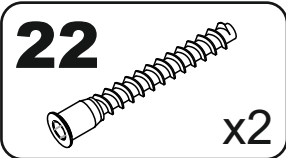
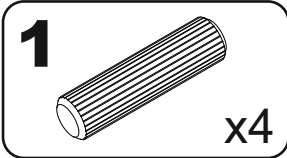

9

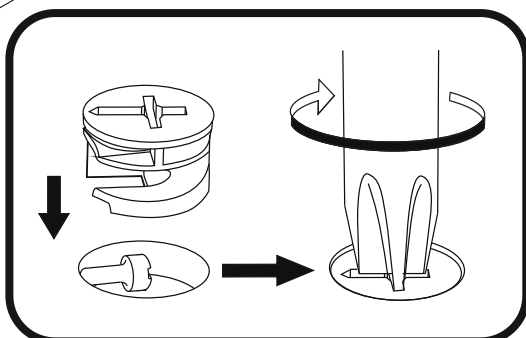
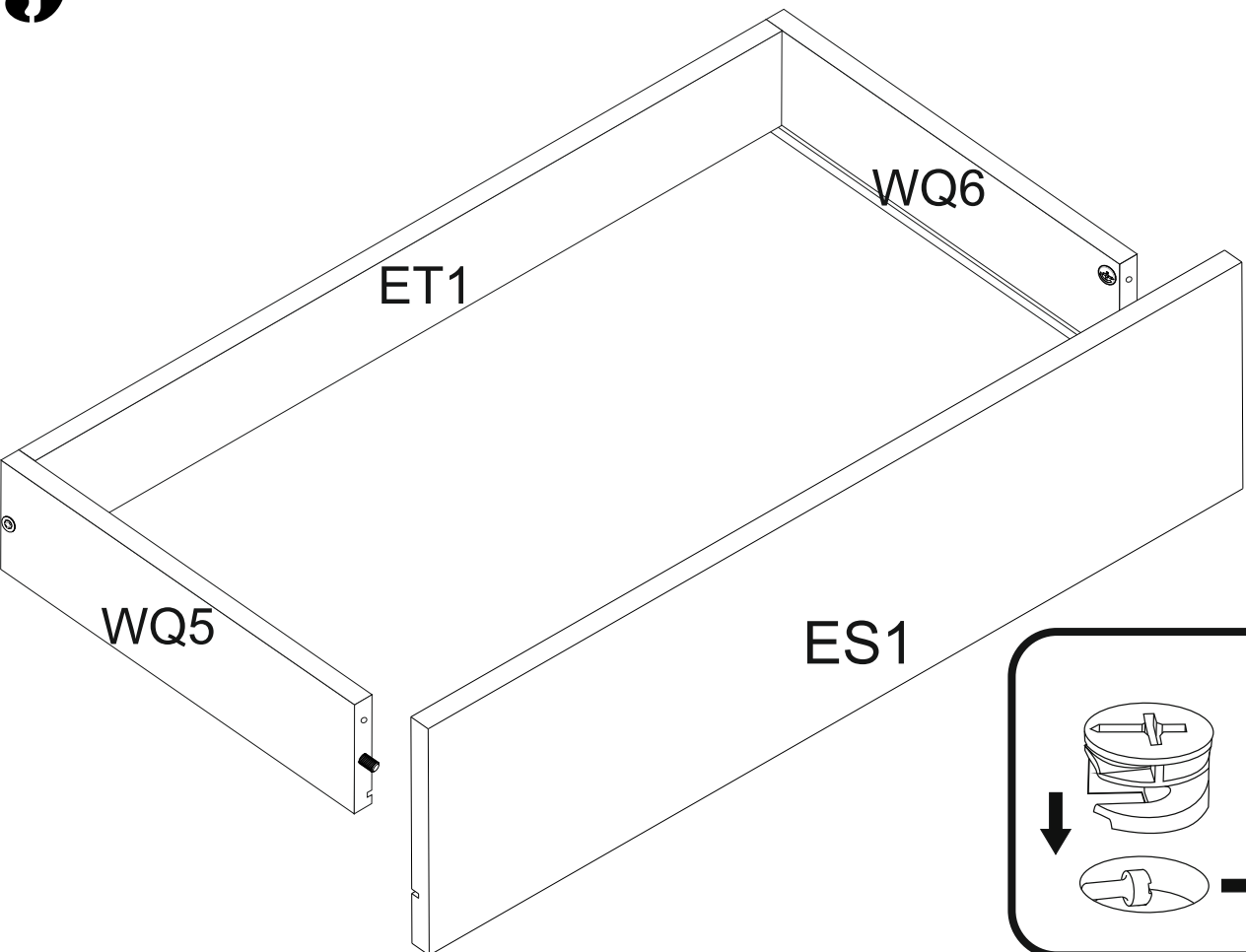

10

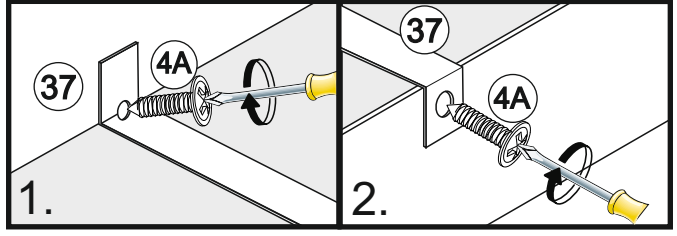
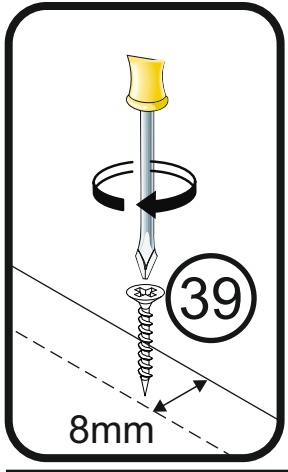
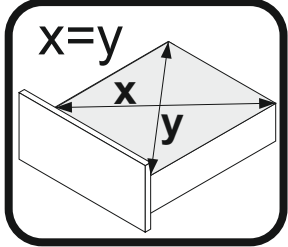

4A 4x16
x2

37
x1

39 3x20
x8

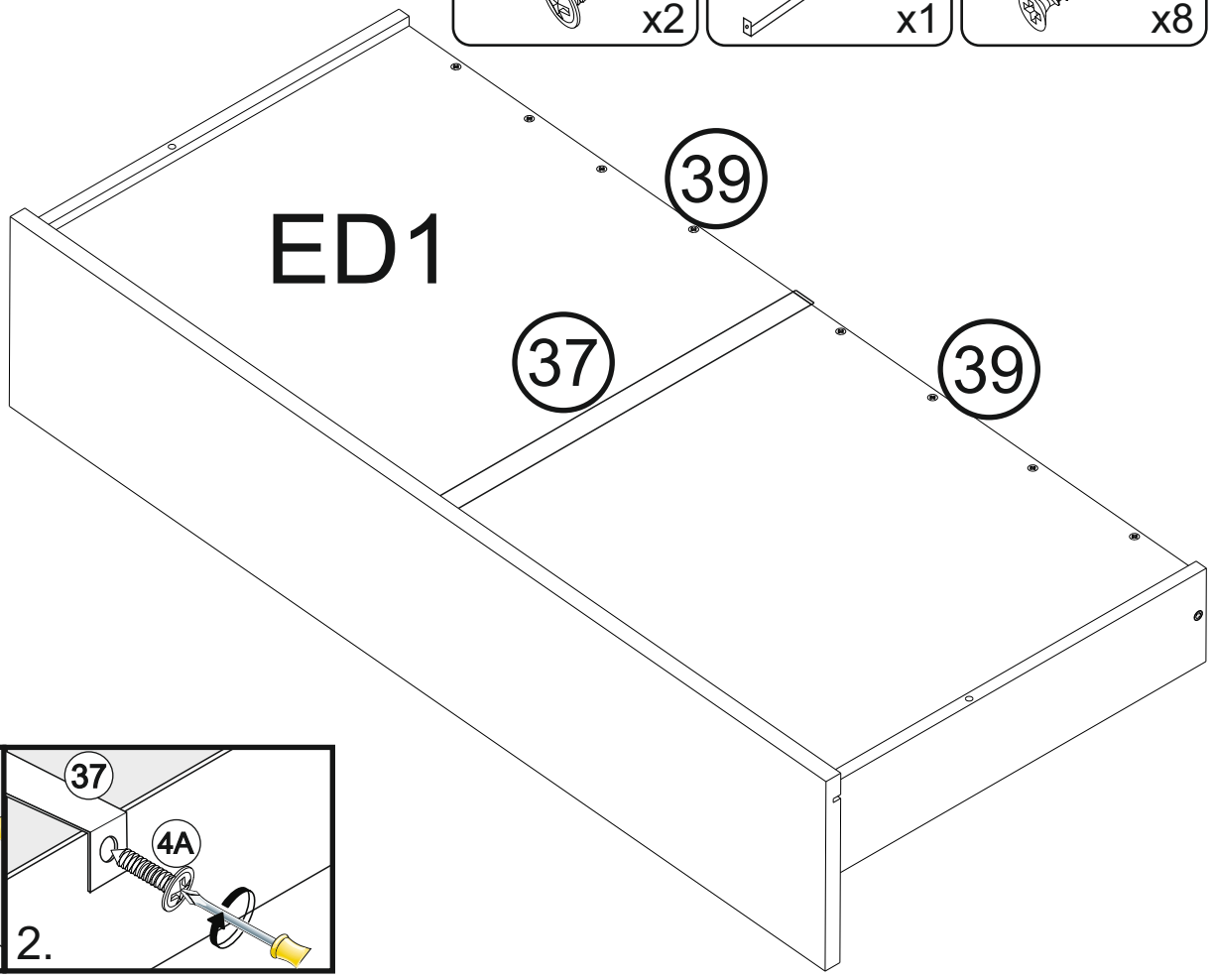

11

2
x4

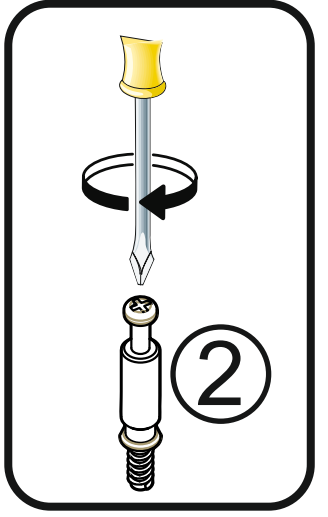
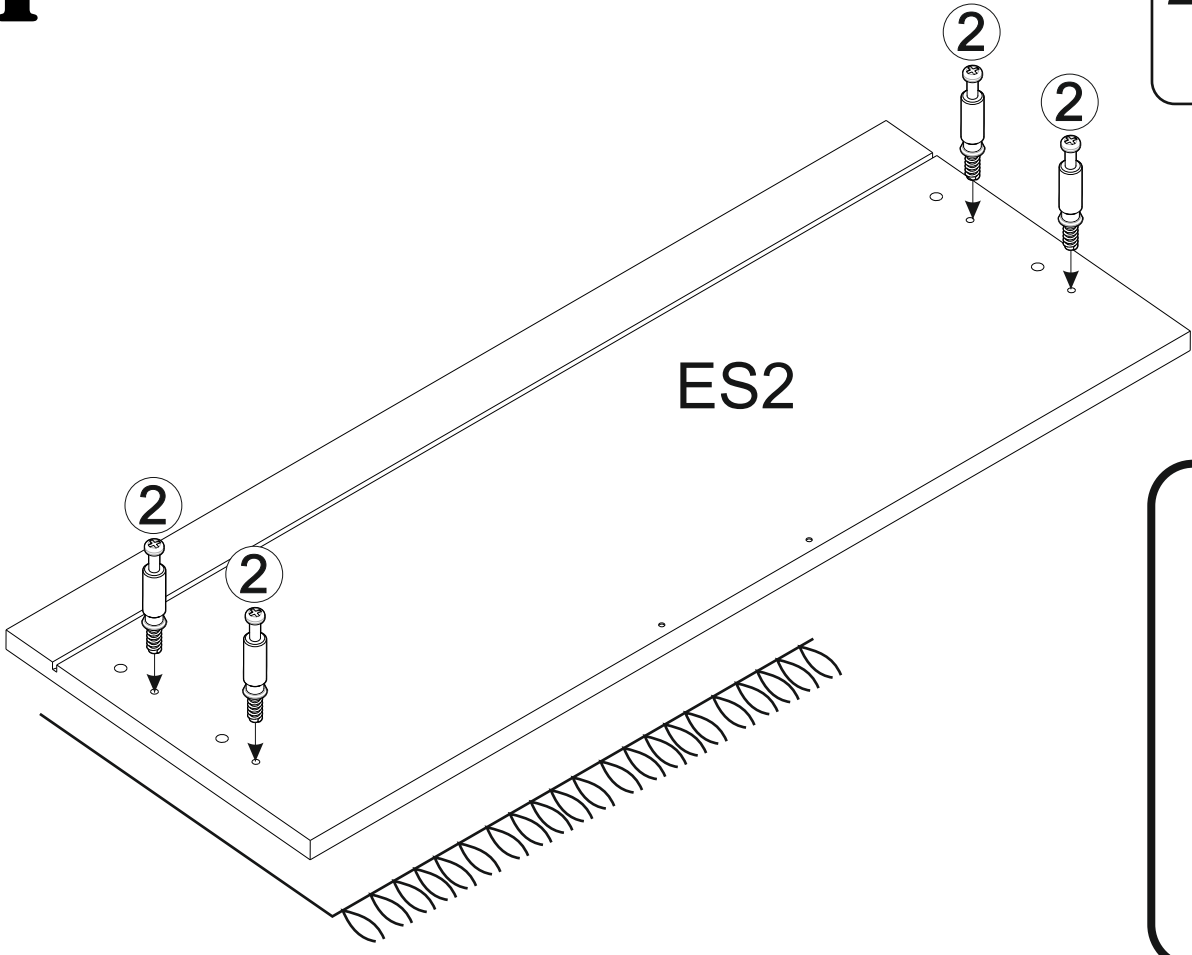

12

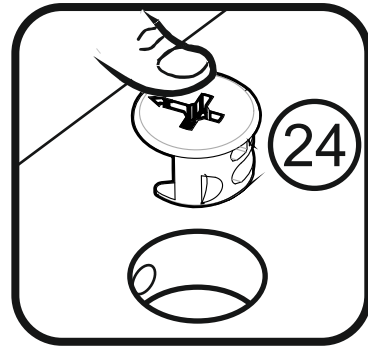
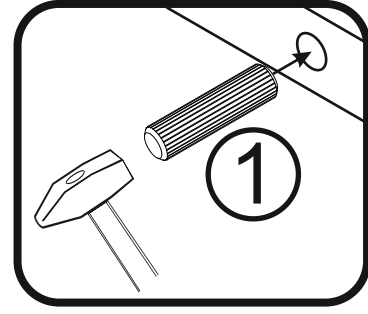
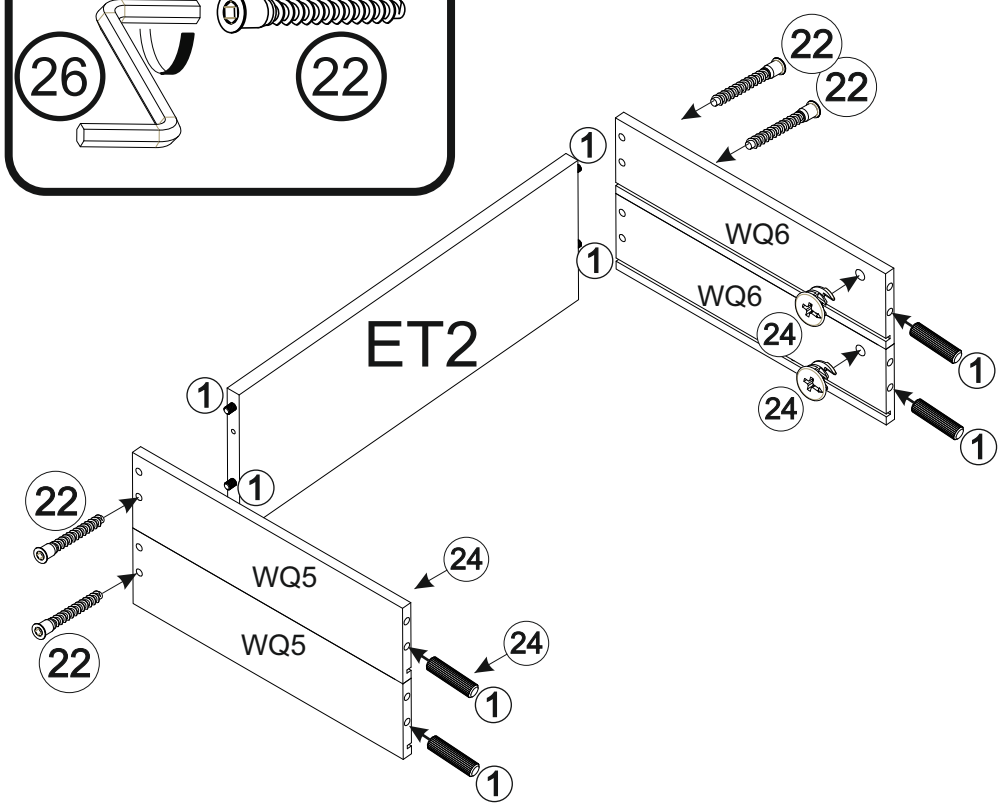
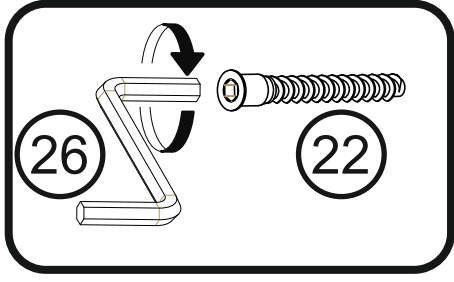
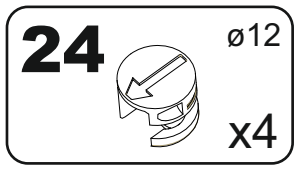
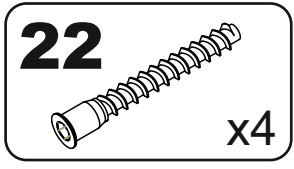
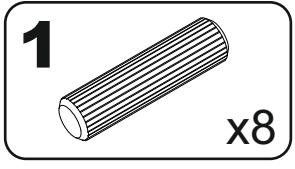

13

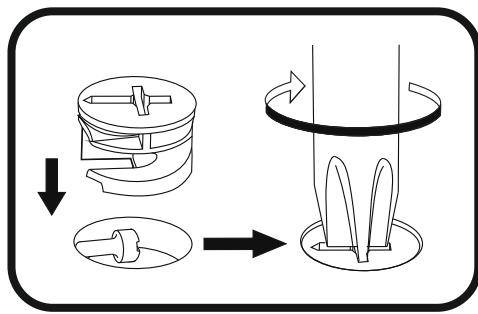
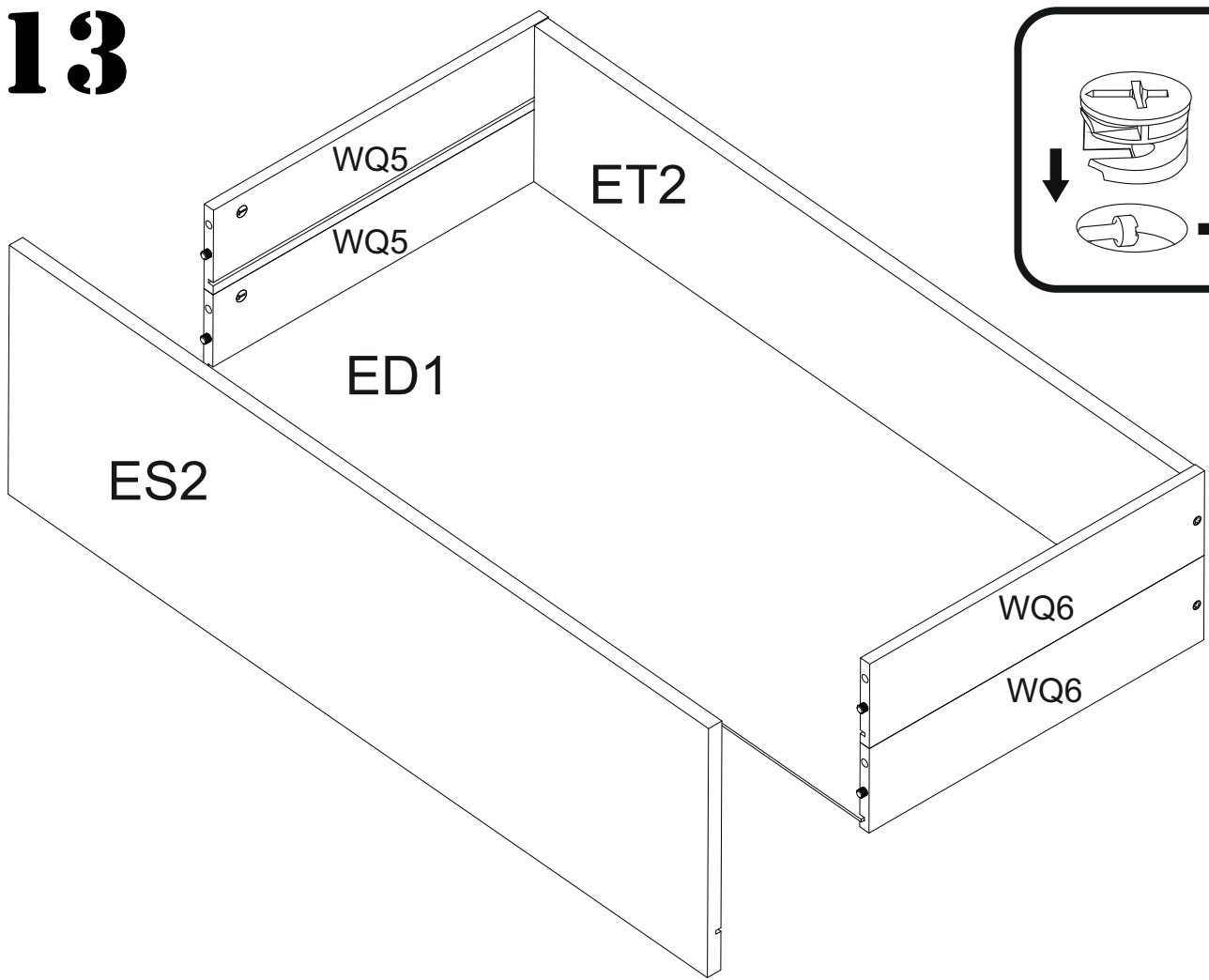

14

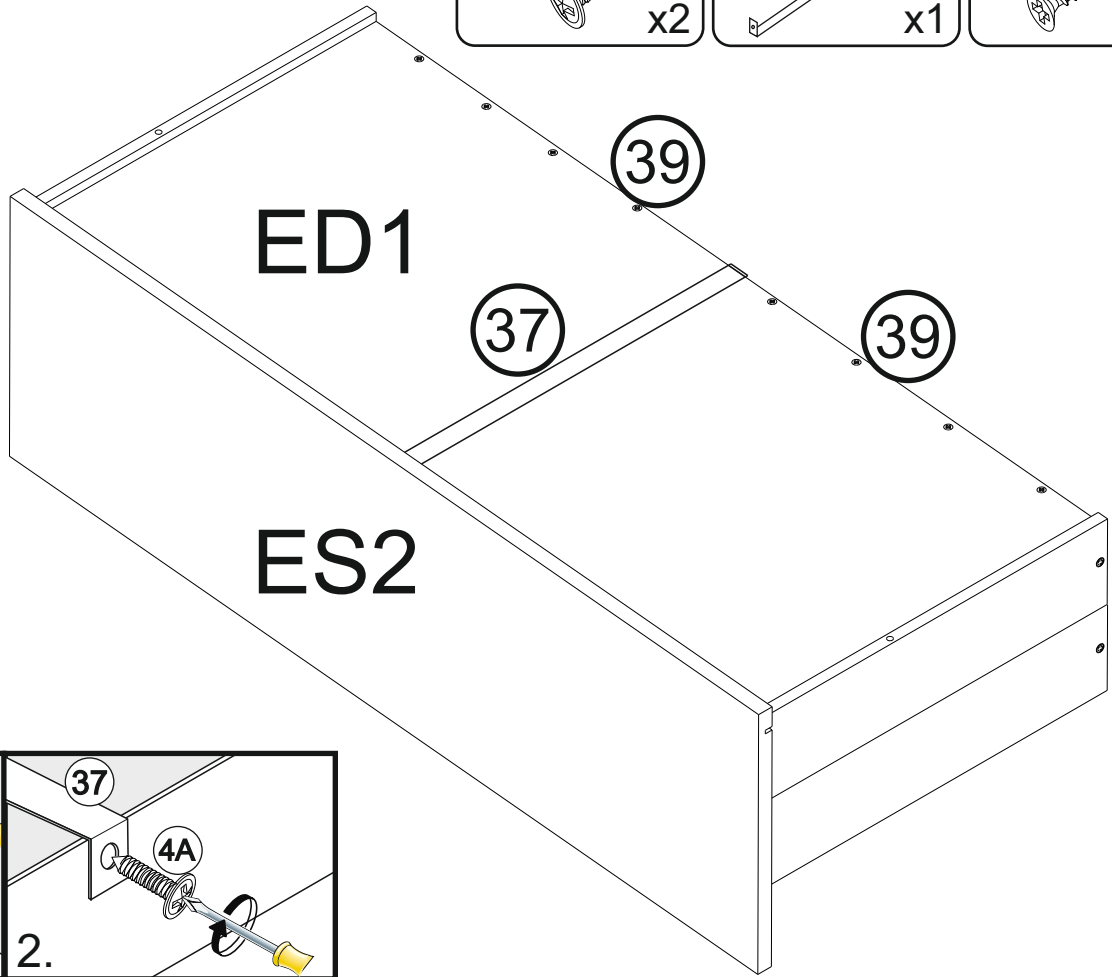
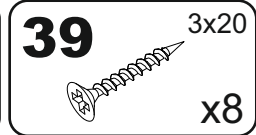
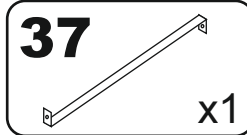
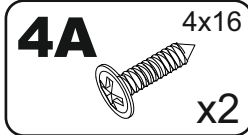
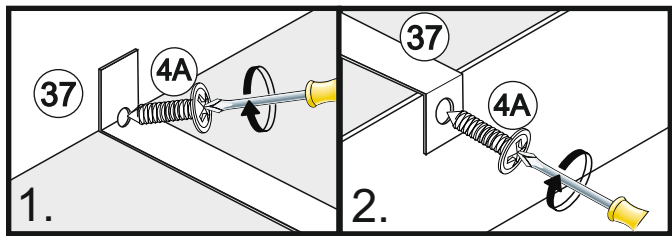
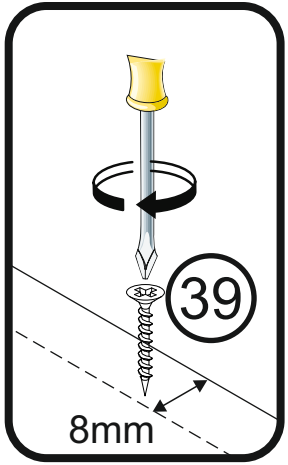
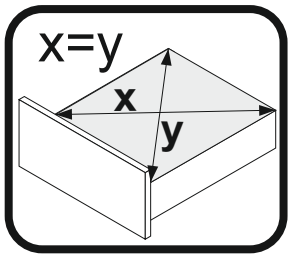

15

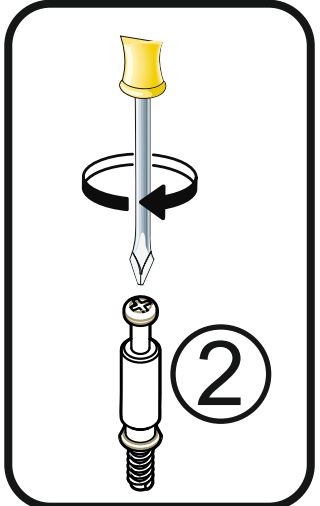
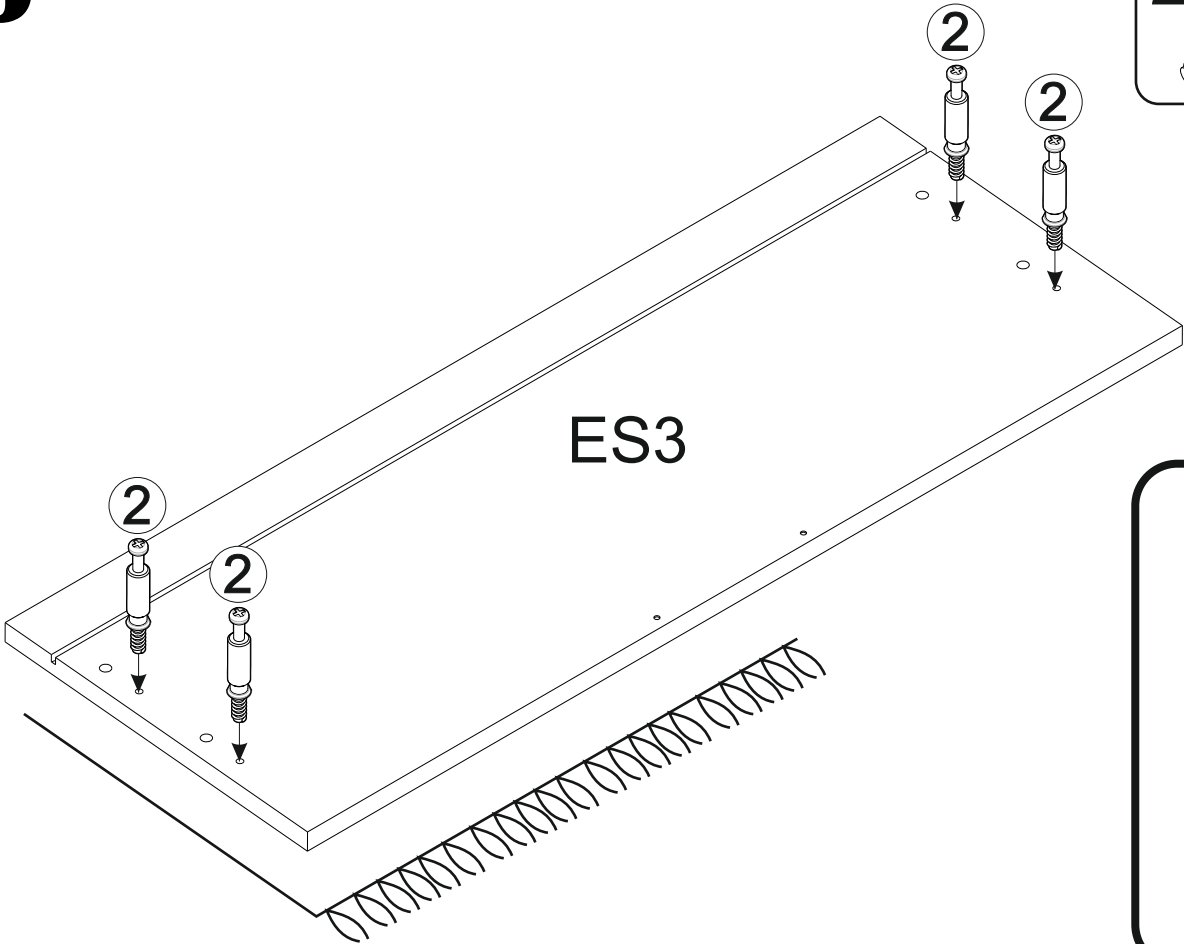
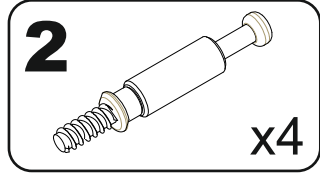

16

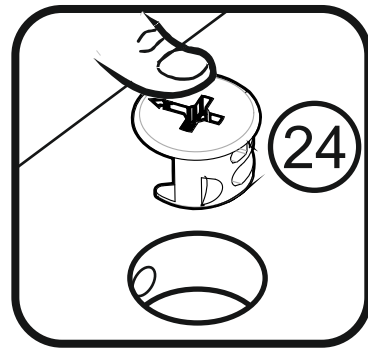
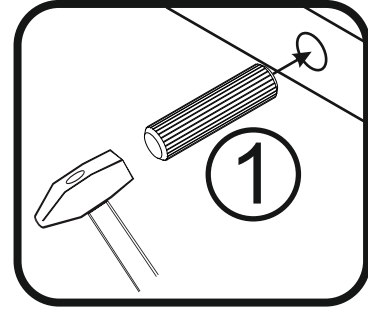
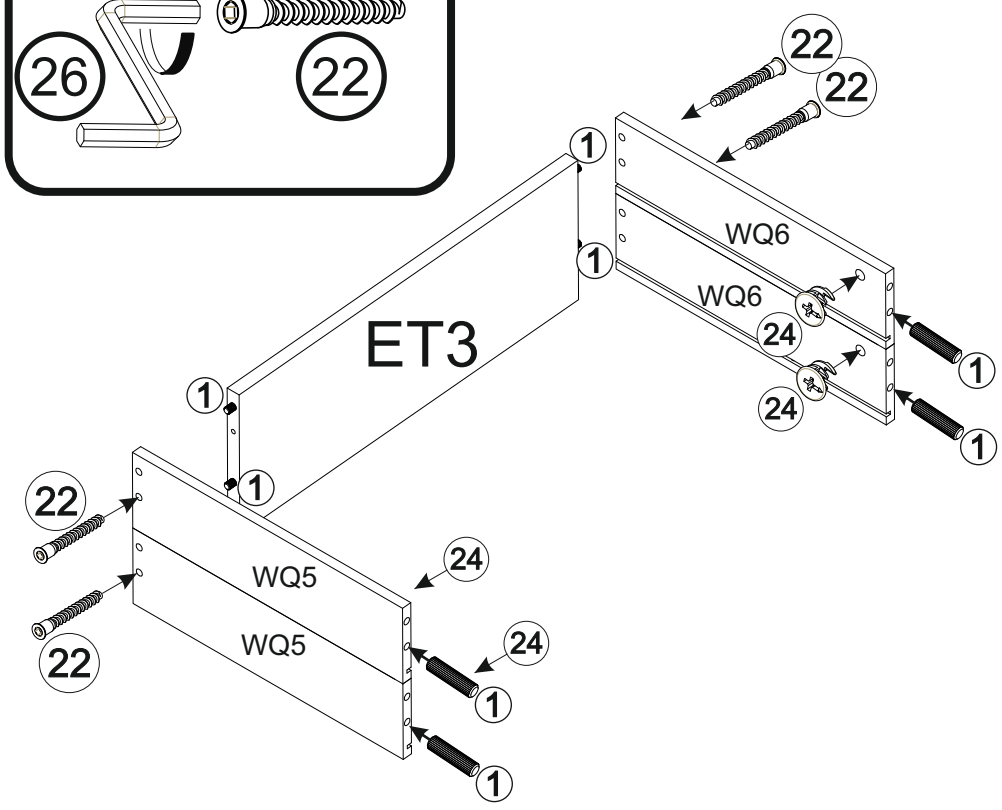
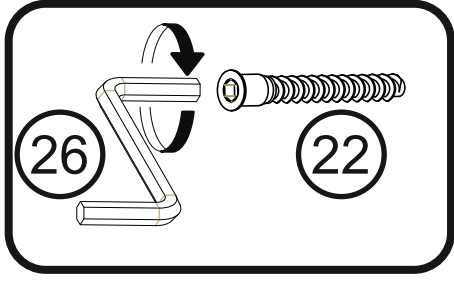
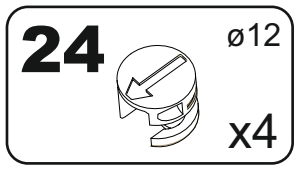
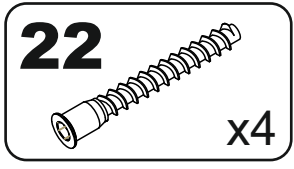
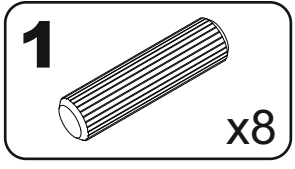

17

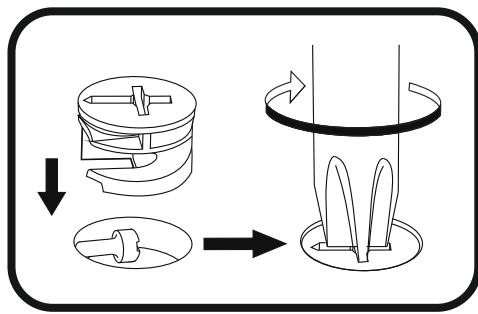
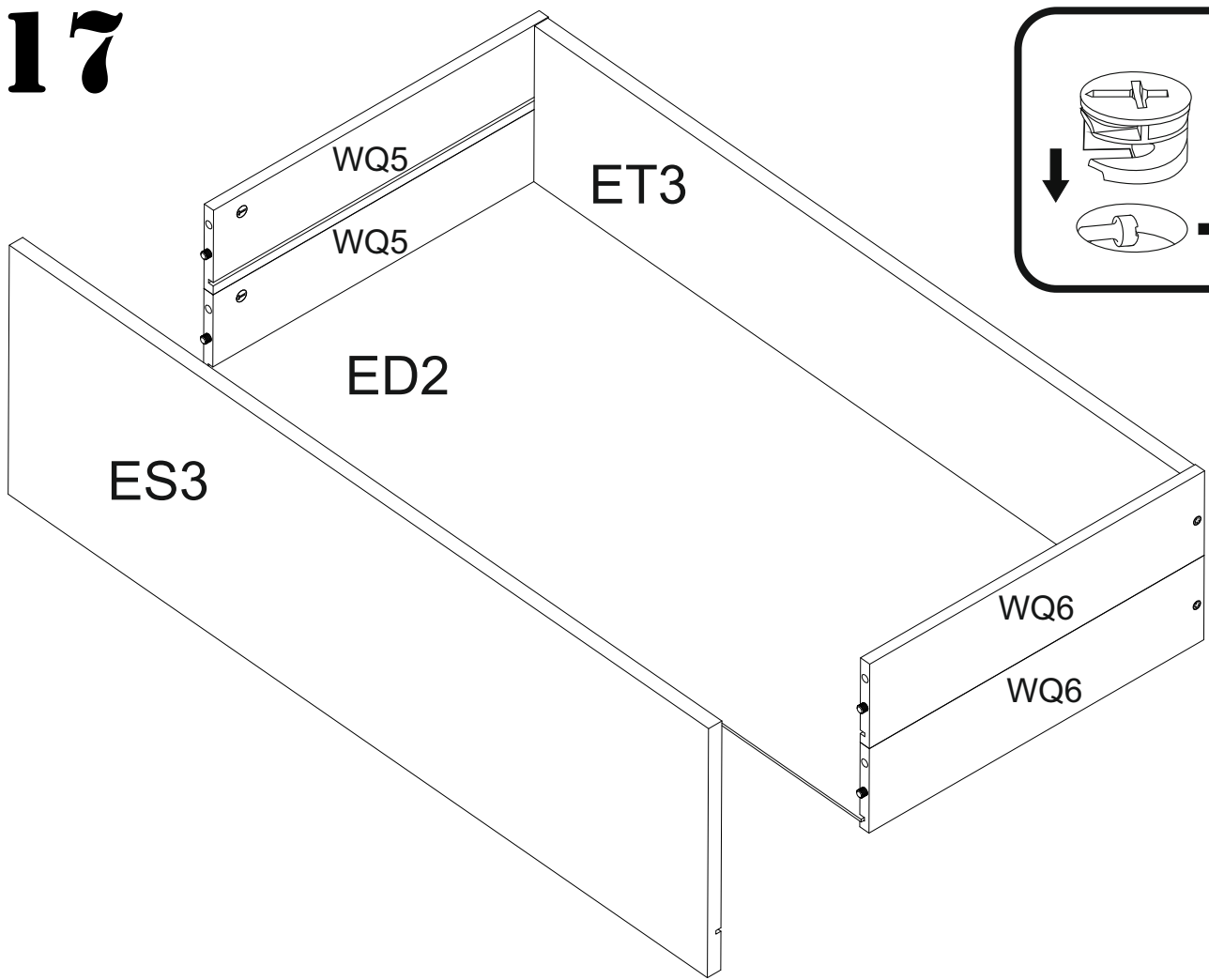

18

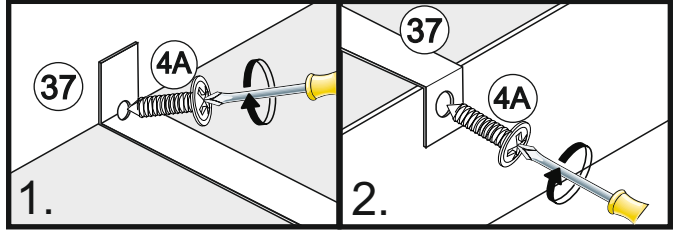
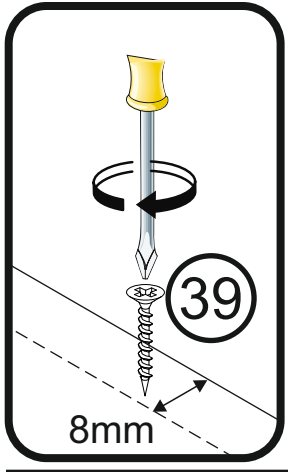
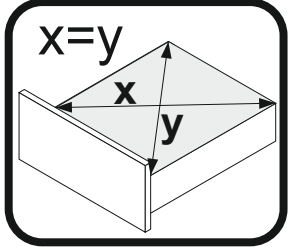

- 4A** 4x16 x2
- 37** x1
- 39** 3x20 x8

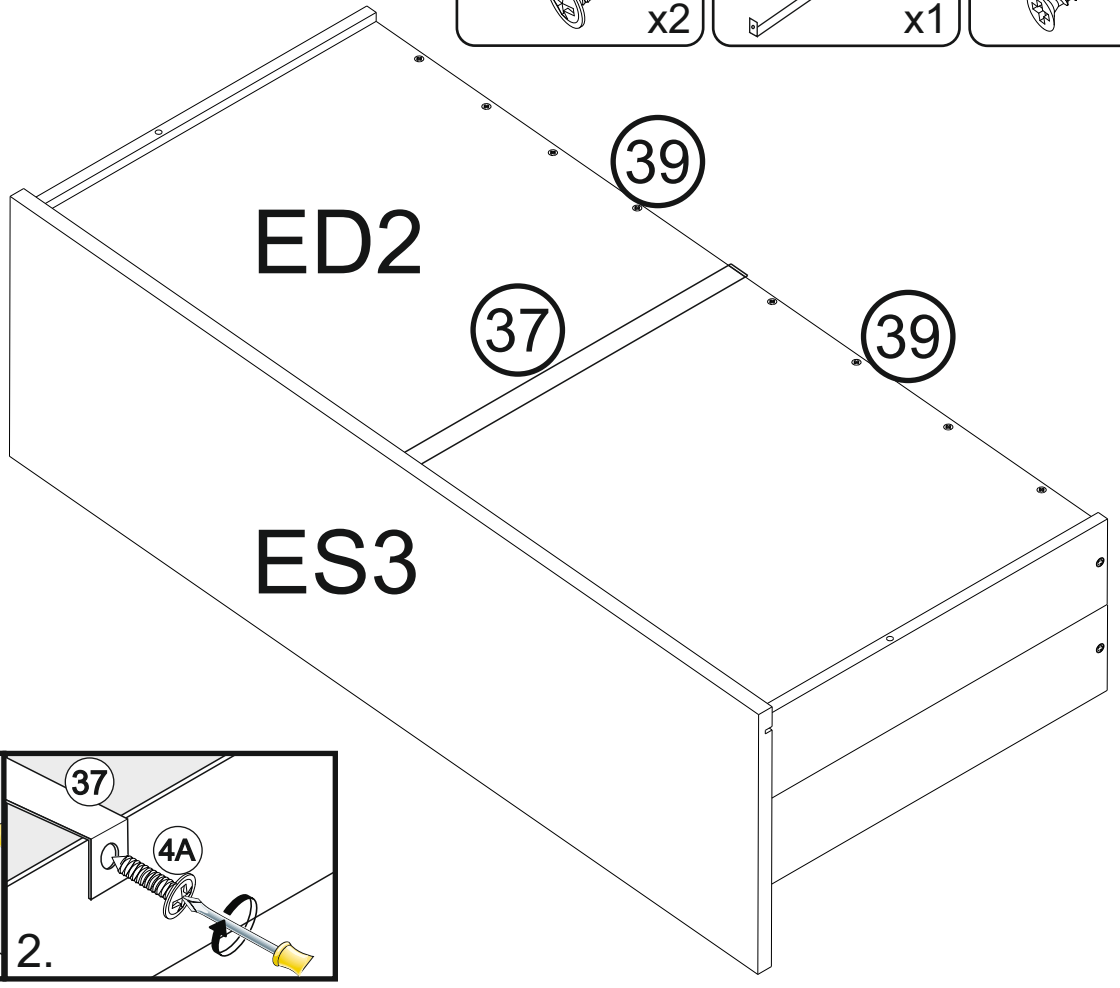

19

- 9A** x3
- 22** x2
- 22A** x2

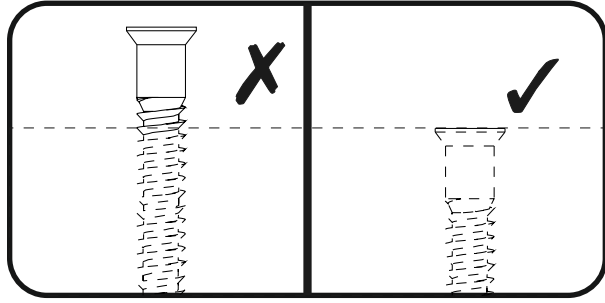
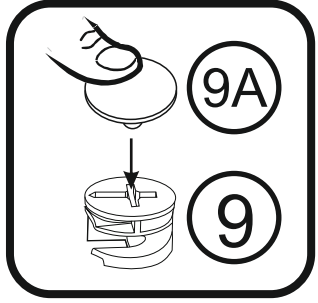
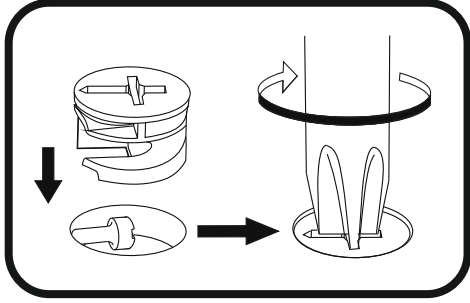
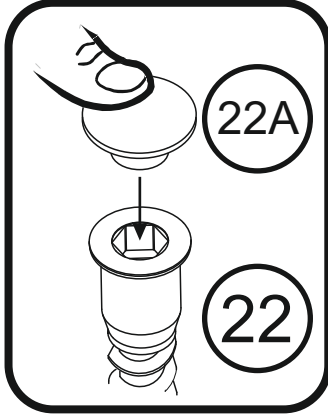
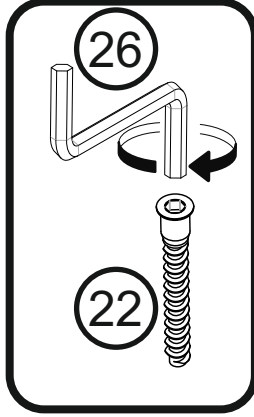
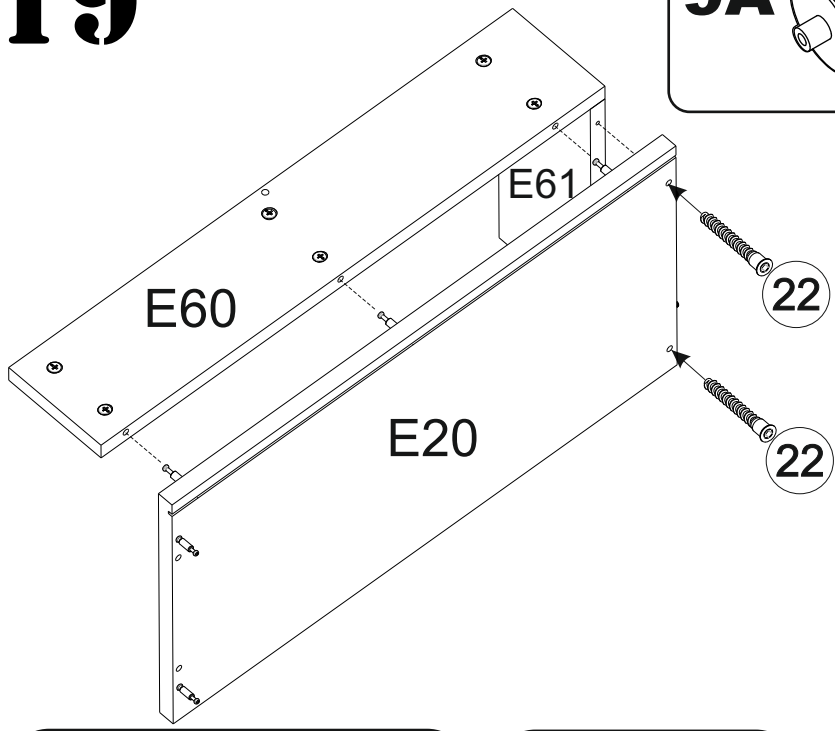

20

21 4x30
x2

22
x2

22A
x2

26
22

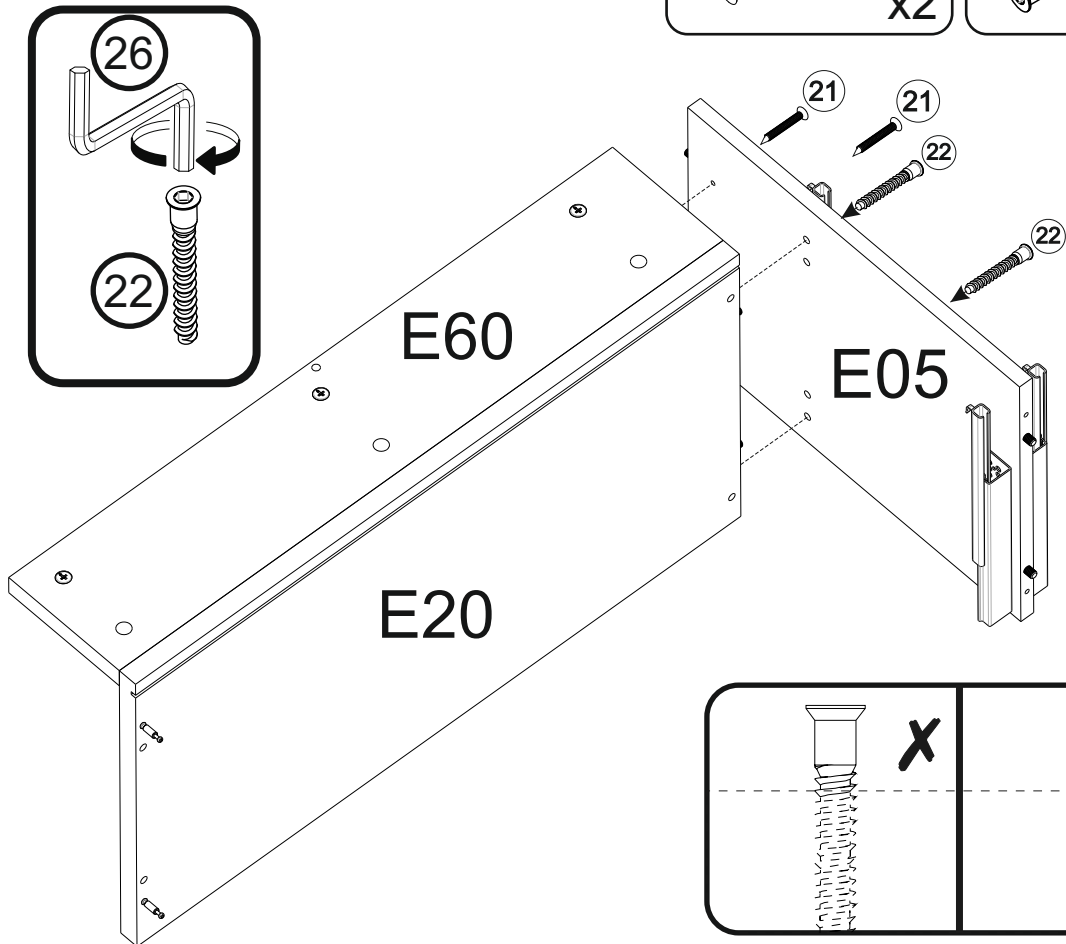

E61
E05
21
22
21

22A
22

21

9A
x9

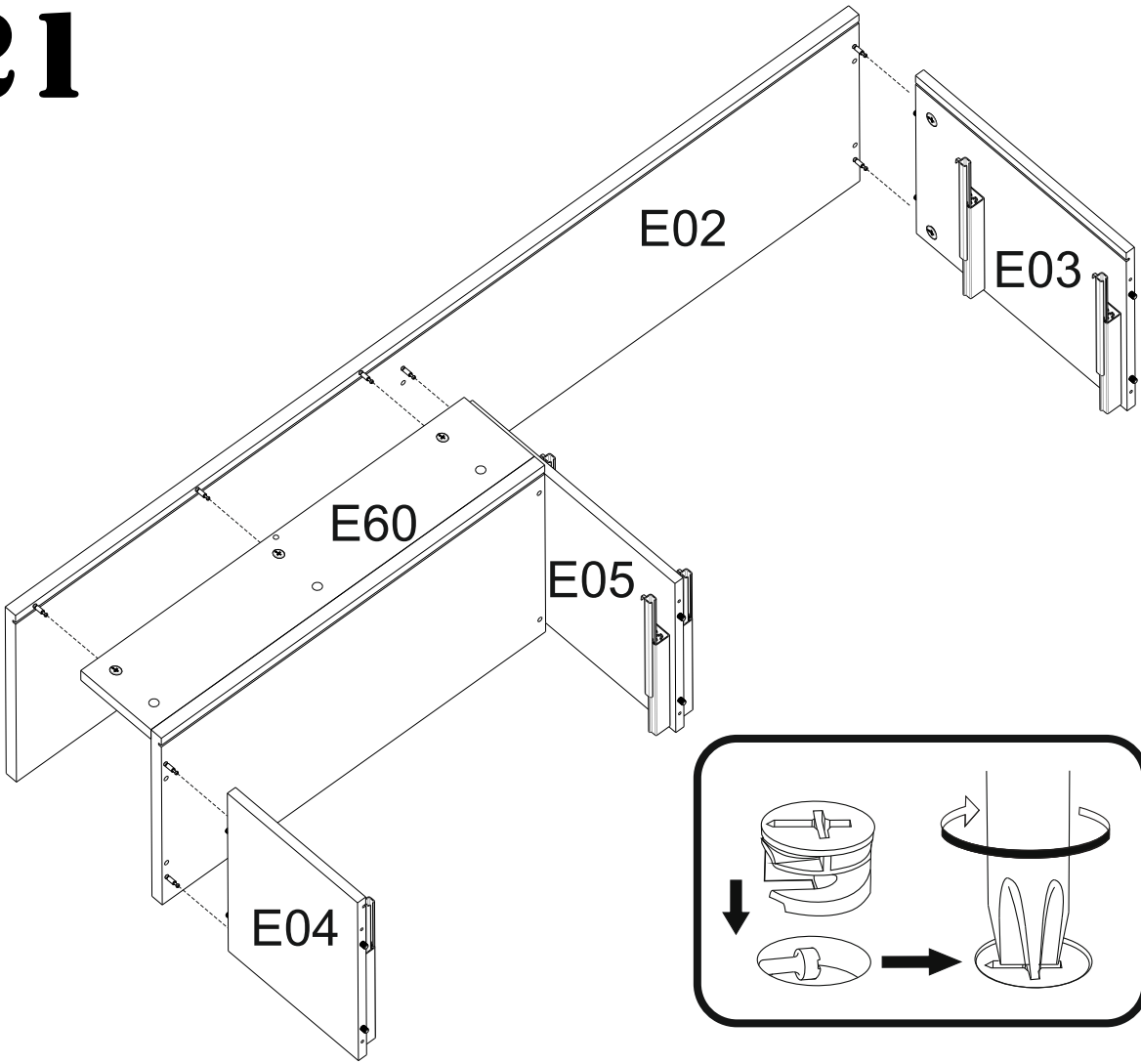

9A
9

22

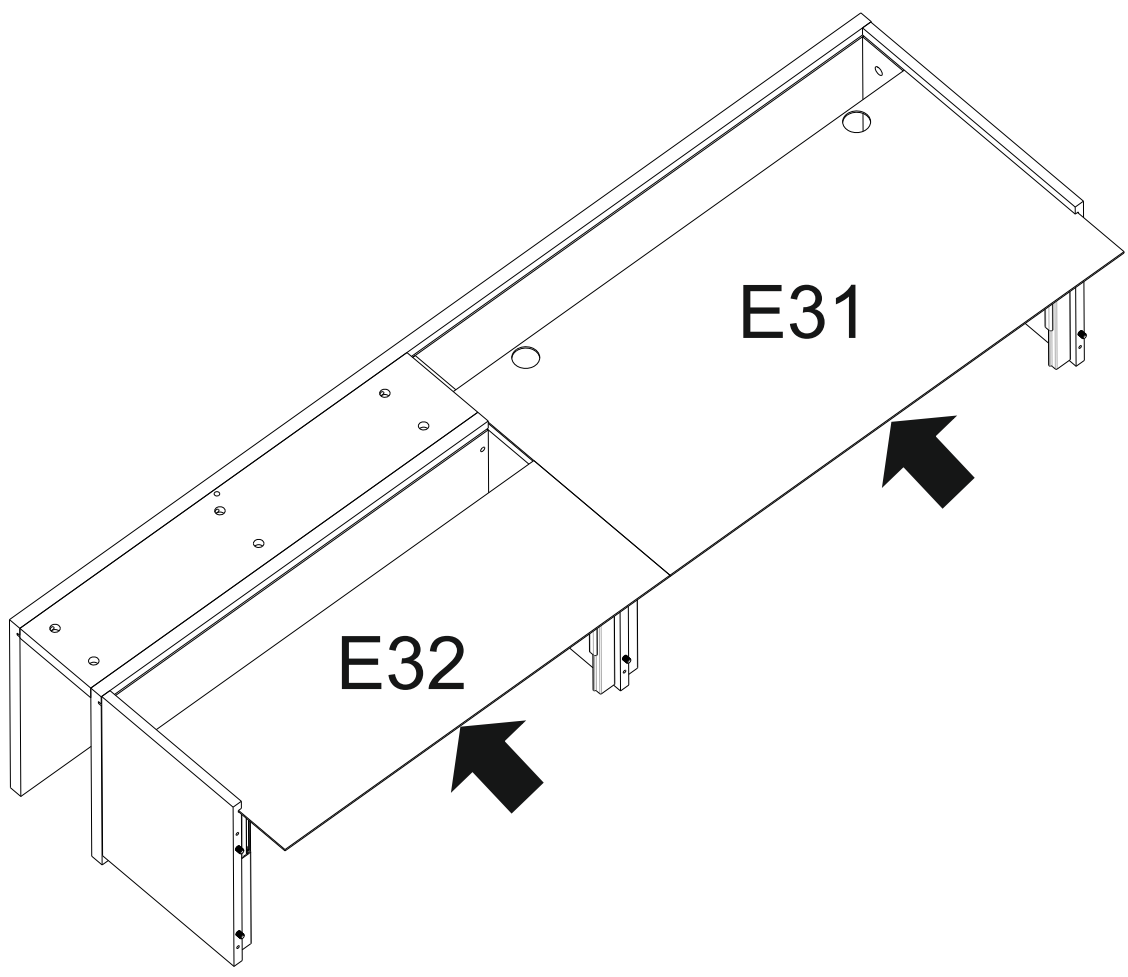

23

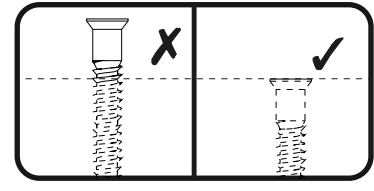
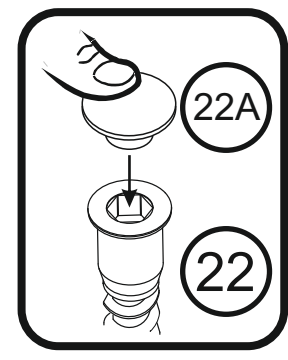
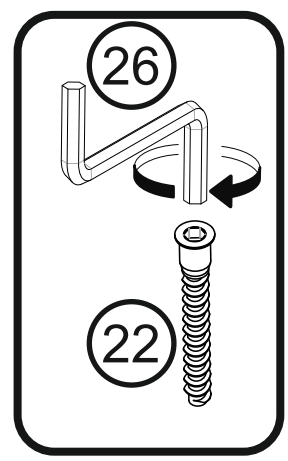
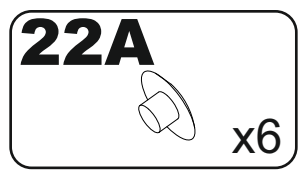
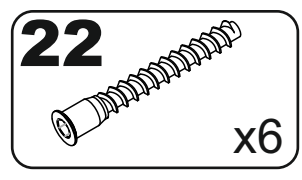
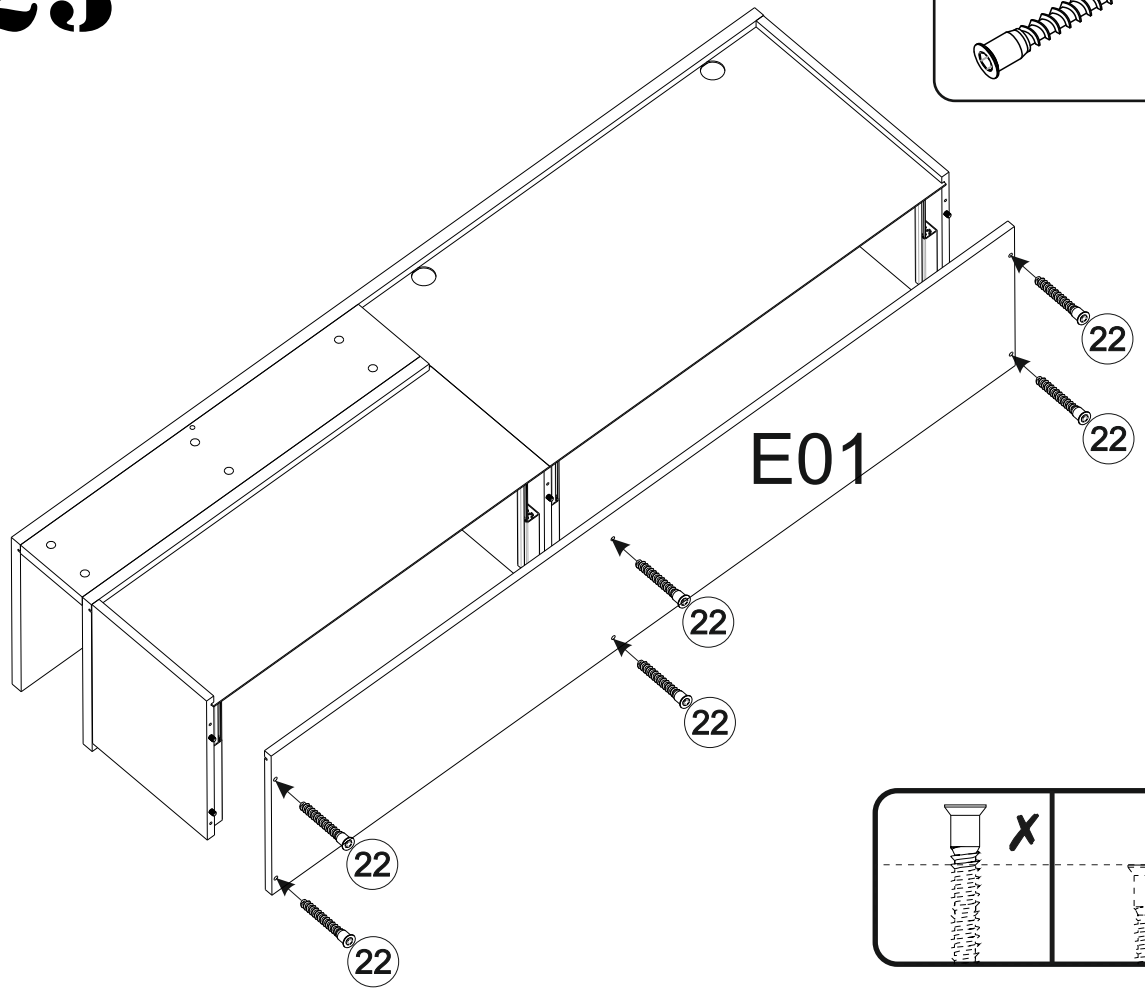

24

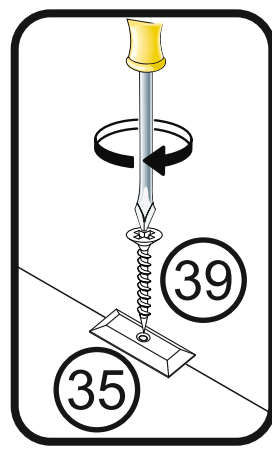
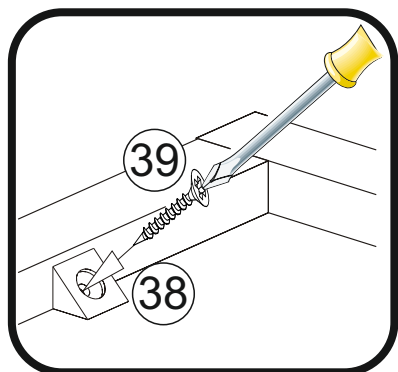
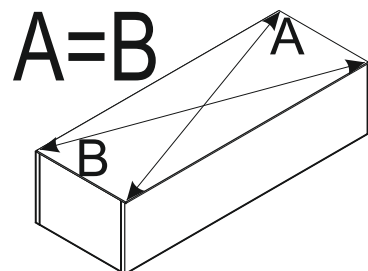
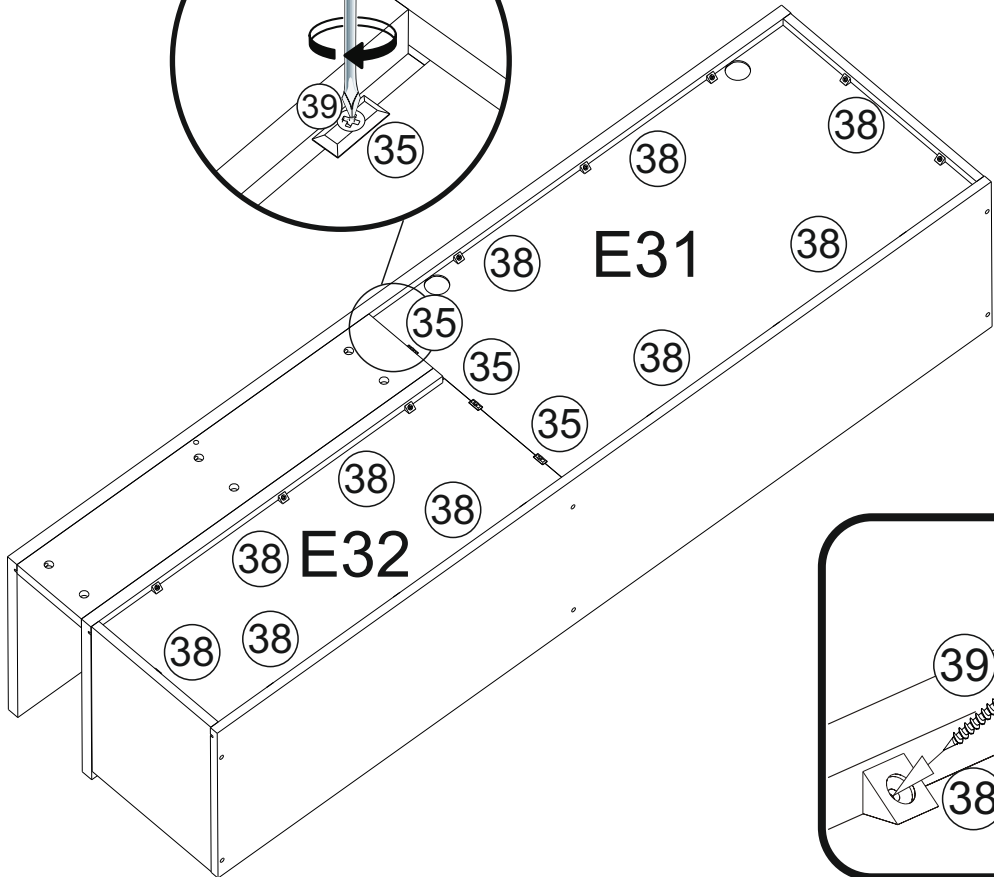
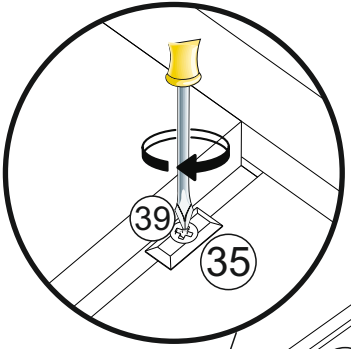
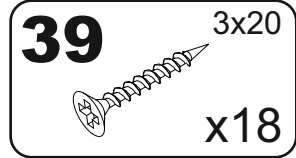
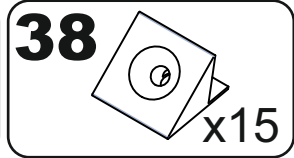
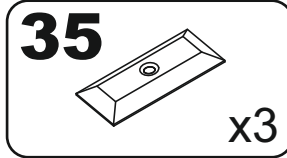

25

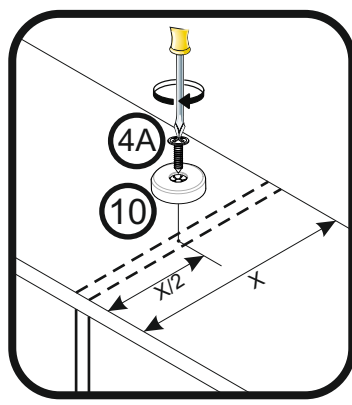
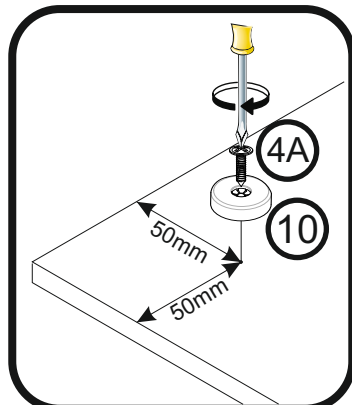
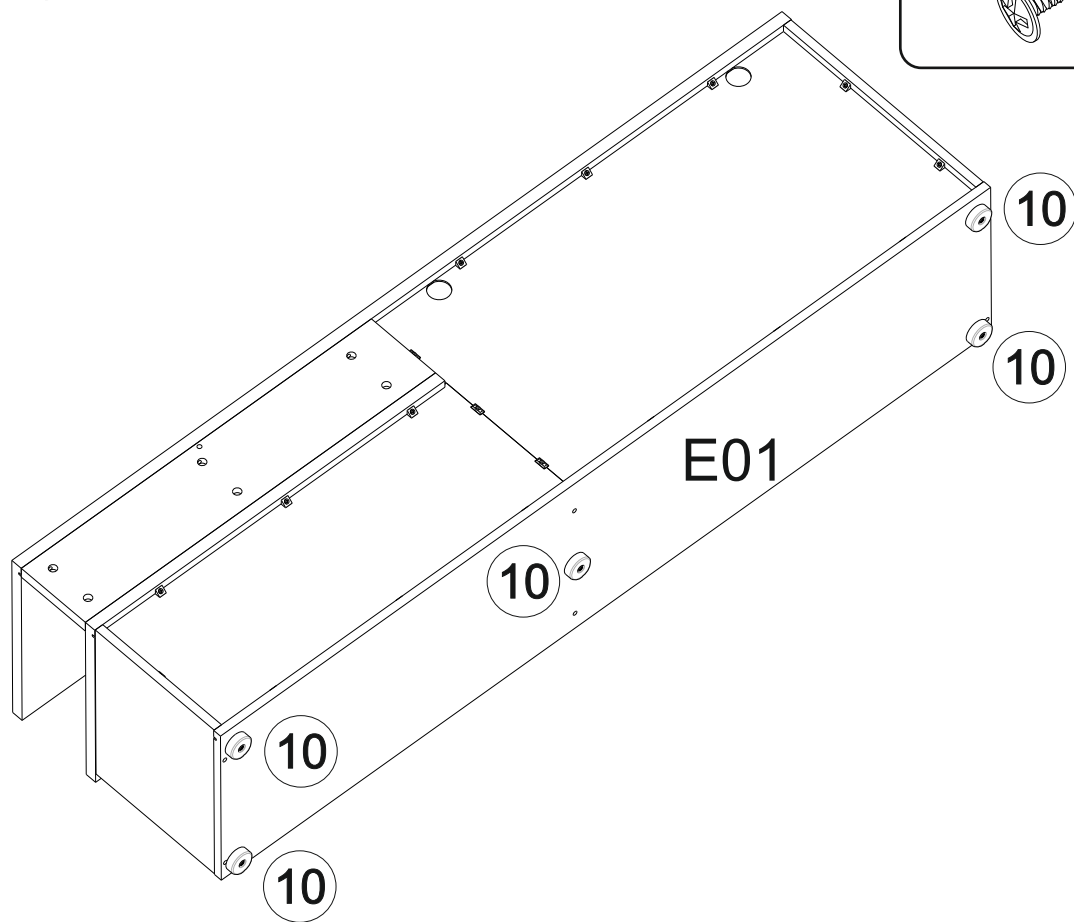
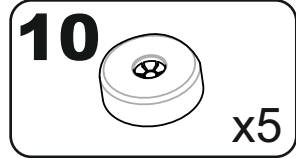
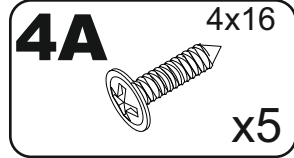

26

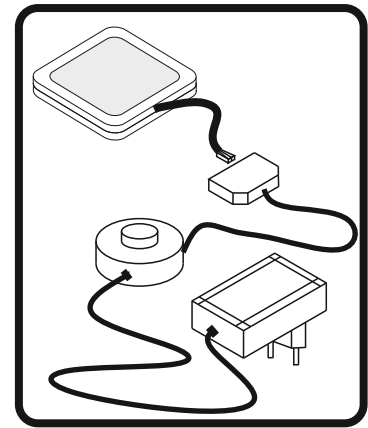
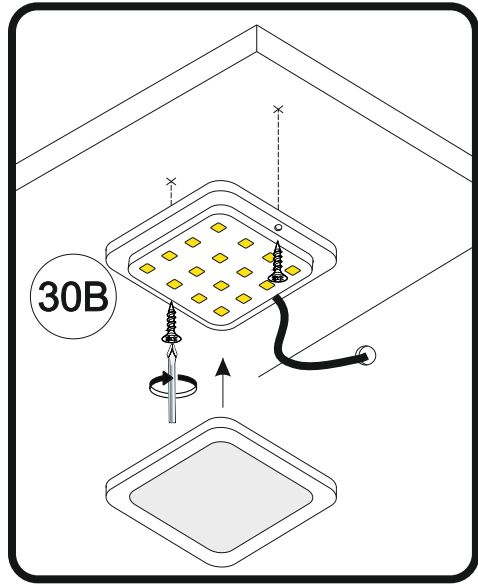
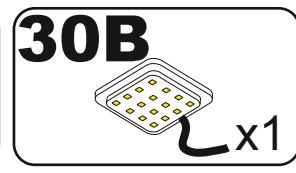
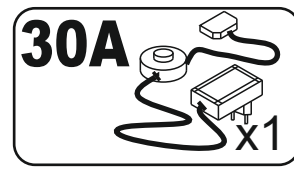
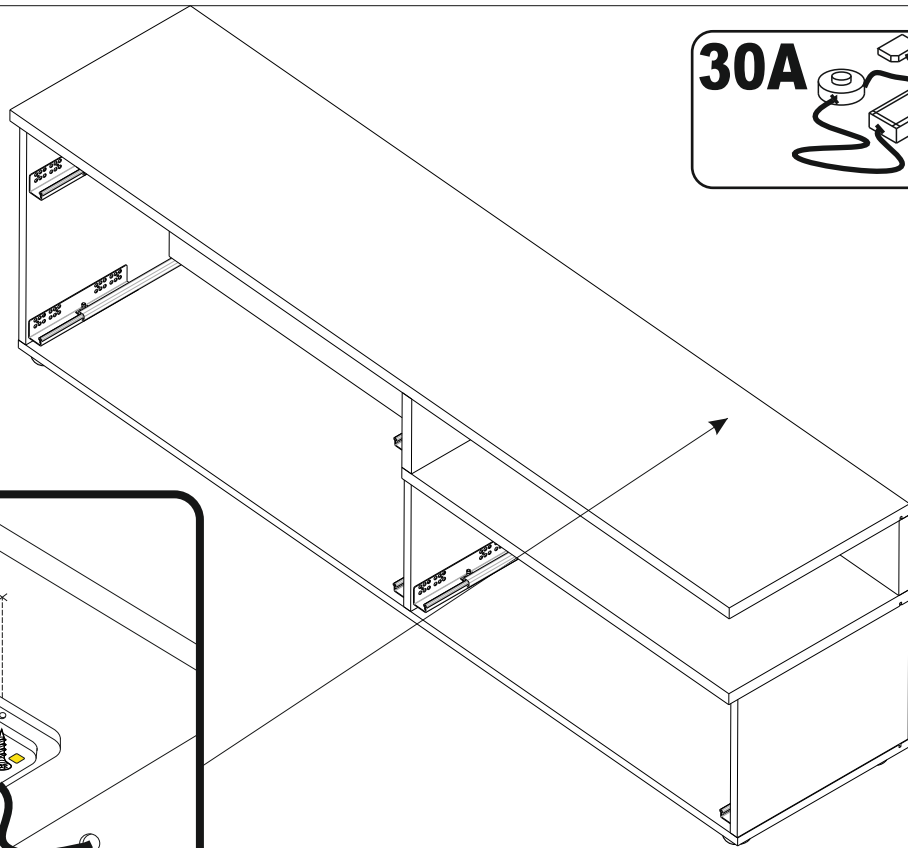

27

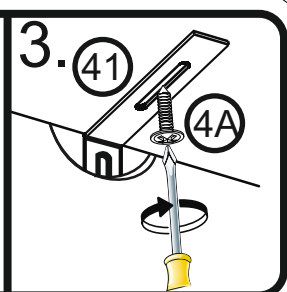
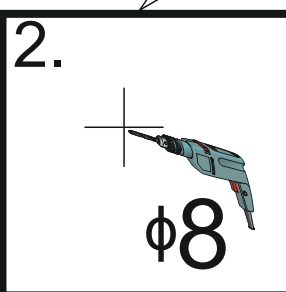
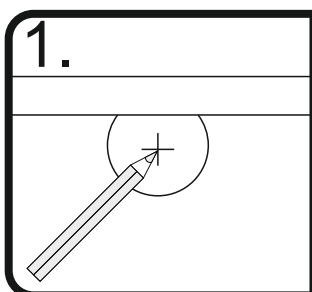
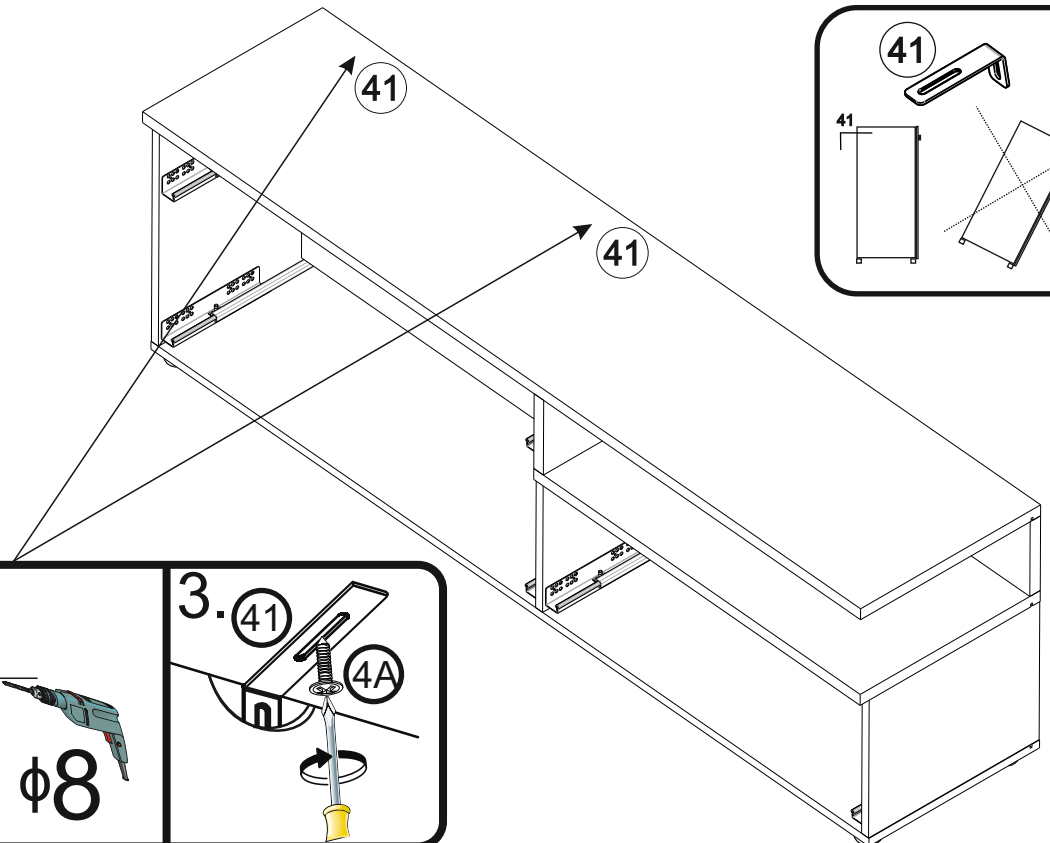
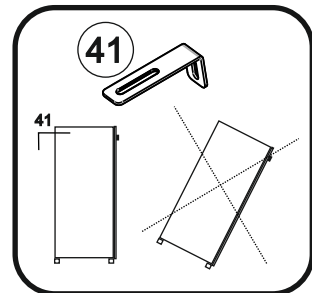
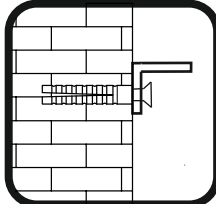
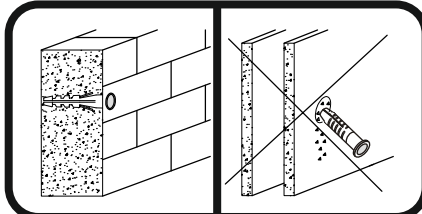
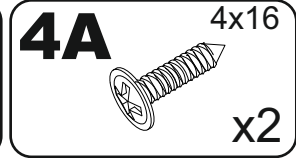
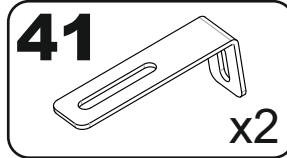

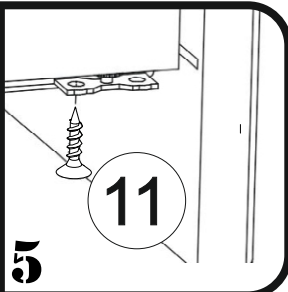
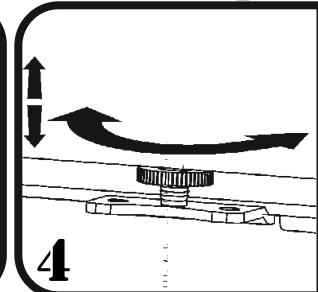
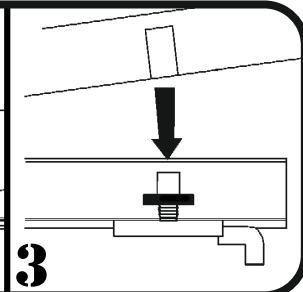
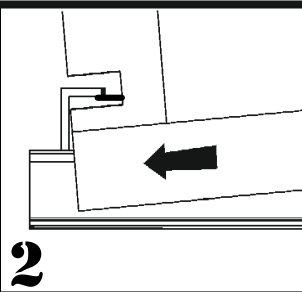
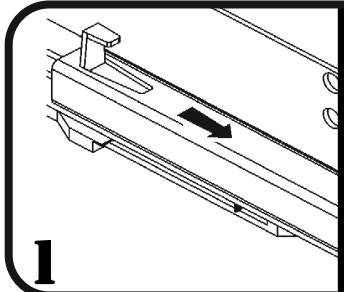
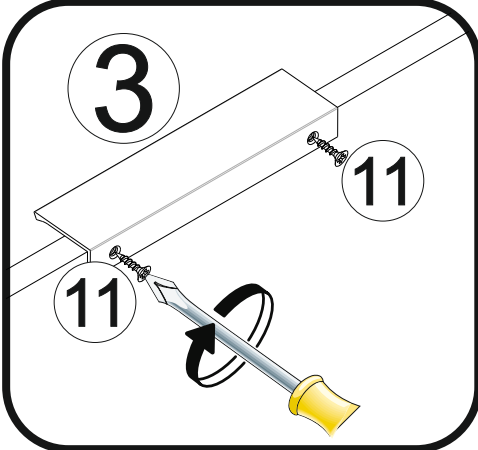
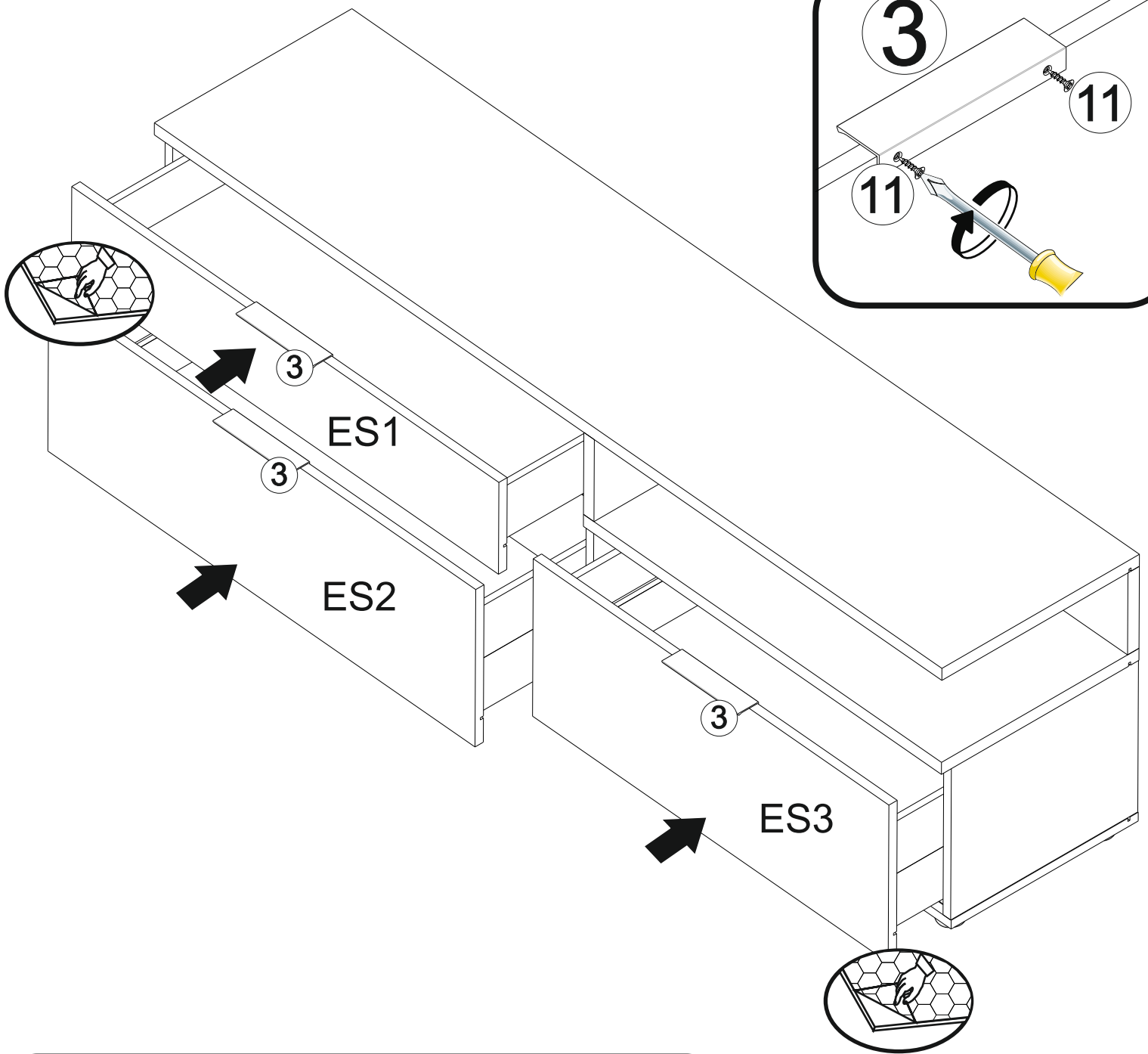
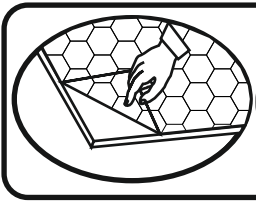
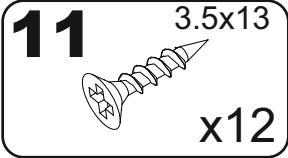
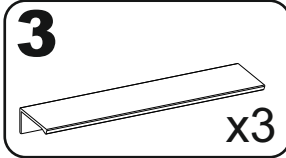

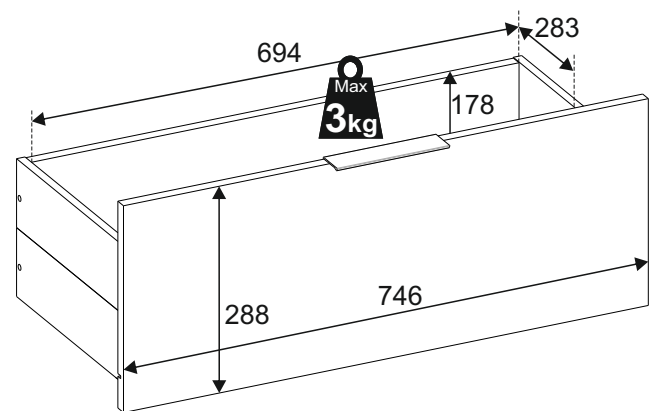
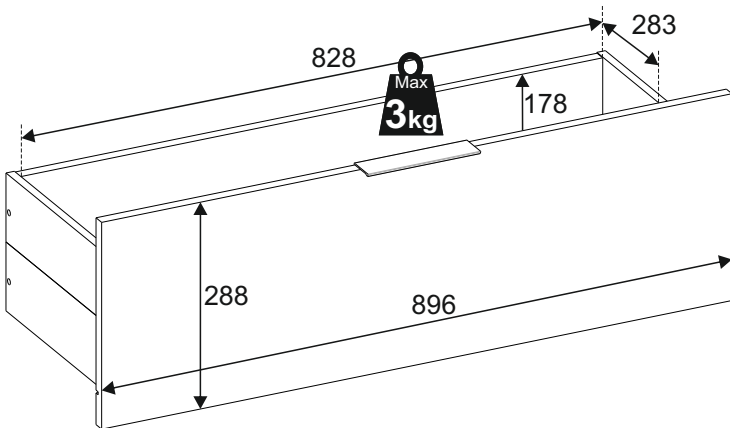
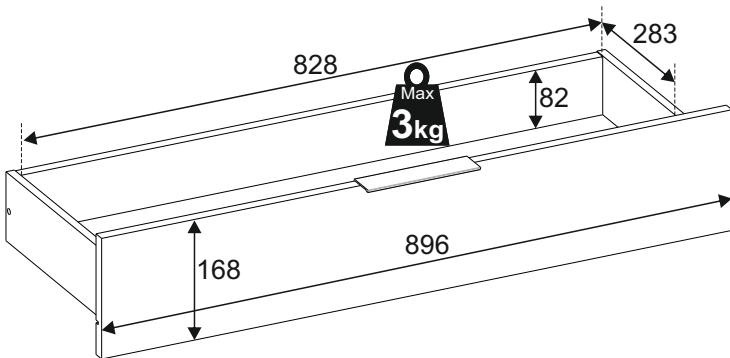
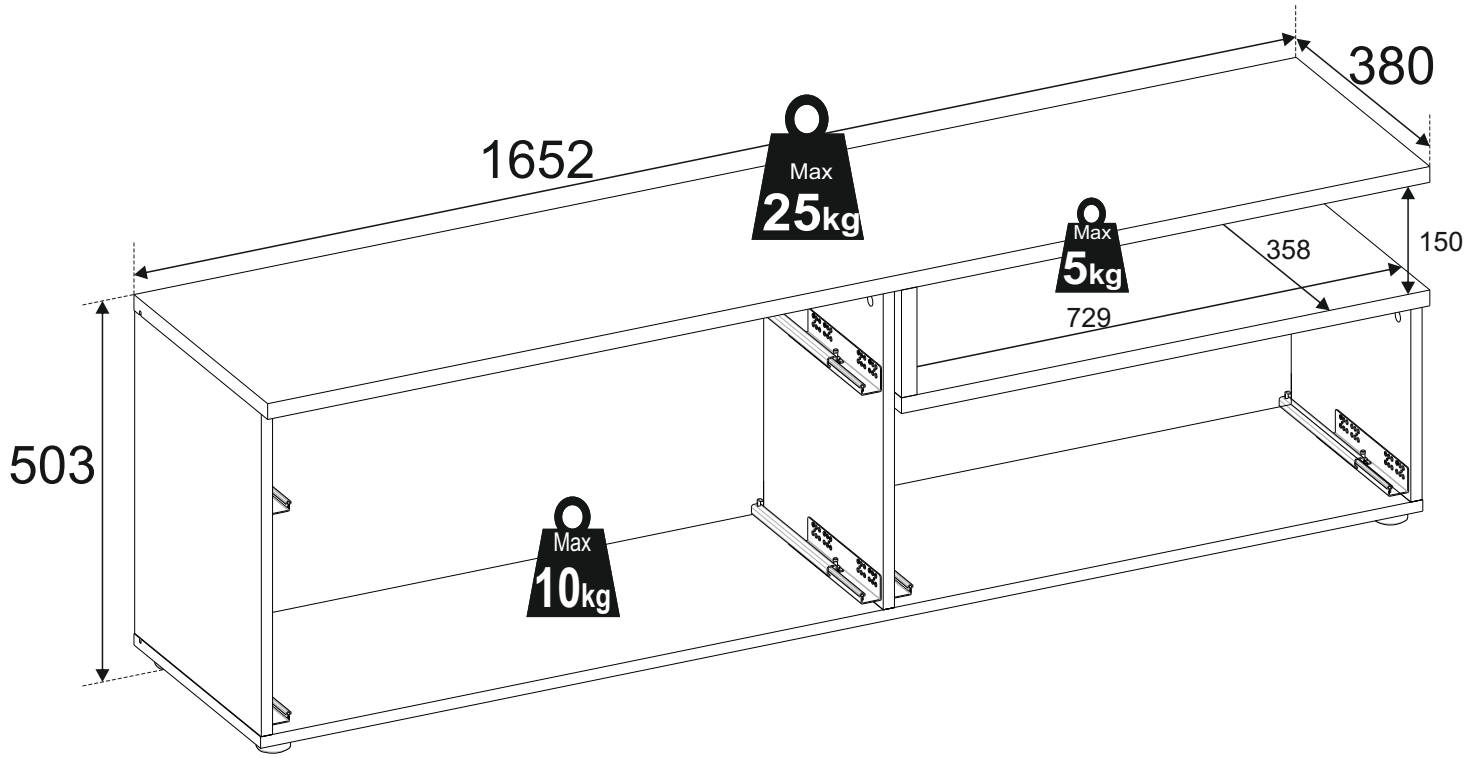
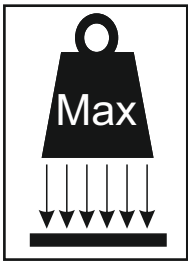

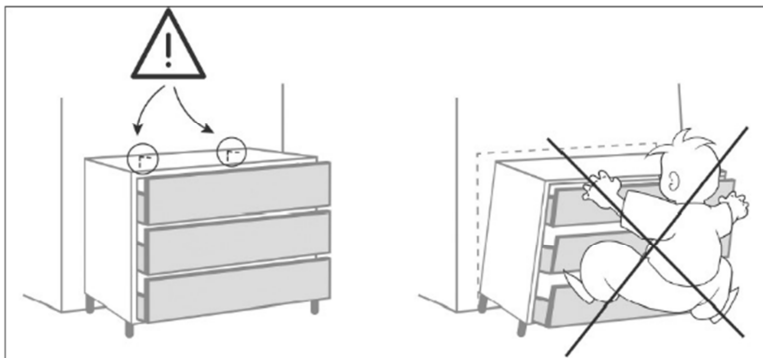
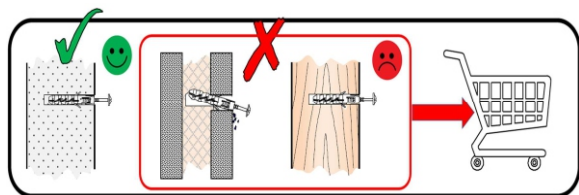

DE	<p>Warnhinweis: Wenn der Ware Dübel und Schrauben beiliegen, sind sie ausschließlich zur Anwendung an Wänden aus massiven und einheitlichen Materialien bestimmt, um ein Umkippen zu verhindern. Vergewissern Sie sich vor dem Bohren, dass sich keine Gas-, Wasser-, oder Stromleitungen an der Bohrstelle befinden. Zur Befestigung an anderen Wänden müssen Spezialdübel verwendet werden. Erkundigen Sie sich im Handel nach den für die jeweilige Wandbeschaffenheit geeigneten Schrauben und oder Dübel. Für eine unsachgemäße Montage und dadurch entstandene Schäden übernimmt der Hersteller keine Haftung. Bitte alle Schrauben in regelmäßigen Abständen überprüfen und nachziehen.</p>
FR	<p>Avertissement : Si des chevilles et des vis sont fournies avec l'article, elles sont exclusivement destinées à être utilisées sur des murs en matériaux massifs et homogènes pour éviter tout basculement. Avant de percer, assurez-vous qu'aucune conduite de gaz, d'eau ou d'électricité ne se trouve à l'endroit où vous percez. Pour la fixation sur d'autres murs, il faut utiliser des chevilles spéciales. Renseignez-vous en magasin sur les vis et les chevilles adaptées à chaque type de mur. Le fabricant décline toute responsabilité en cas de montage incorrect et de dommages qui en résulteraient. Veuillez vérifier et resserrer toutes les vis à intervalles réguliers.</p> <p>ATTENTION ! Les meubles contenant des panneaux à base de bois (panneaux de particules, panneaux de fibres, contreplaqué...) peuvent émettre des substances polluantes dans l'air intérieur. Il est ainsi recommandé, après l'installation du meuble dans son logement, d'aérer fréquemment la pièce concernée pendant au moins quatre semaines afin de réduire son exposition aux polluants émis par le meuble</p> <p>LED : Ce luminaire est un produit de décoration. Ce luminaire ne convient pas pour l'éclairage principal d'une pièce de la maison.</p>
UK	<p>Warning: If dowels and screws are included with the product, they are only intended for use on walls made of solid and uniform materials to prevent them from tipping over. Before drilling, make sure that there are no gas, water or electricity pipes at the drilling site. Special anchors must be used for fastening to other walls. Ask in the trade for the screws and or dowels suitable for the respective wall condition. The manufacturer accepts no liability for improper installation and any resulting damage. Please check and retighten all screws at regular intervals.</p>
IT	<p>Avvertenza: Se con il prodotto sono forniti tasselli e viti, questi sono destinati esclusivamente all'utilizzo su pareti realizzate con materiali solidi ed uniformi, per evitare il ribaltamento. Prima di eseguire i fori assicurarsi che non ci siano condutture di gas, acqua o elettriche vicino al punto di perforazione. Per il fissaggio ad altre pareti è necessario utilizzare tasselli speciali. Chiedere al proprio rivenditore le viti e/o tasselli adatti al tipo di parete in questione. Il produttore non si assume alcuna responsabilità in caso di montaggio improprio e dei danni che ne derivano. Controllare e serrare tutte le viti a distanza regolare.</p>
PL	<p>Ostrzeżenie: Jeżeli do towaru dołączone są kołki i śruby, są one przeznaczone wyłącznie do stosowania na ścianach wykonanych z solidnych i jednorodnych materiałów, aby zapobiec przewróceniu. Przed rozpoczęciem wiercenia należy upewnić się, że w miejscu wiercenia nie są ułożone rury gazowe, wodociągowe lub przewody elektryczne. Do mocowania do innych ścian należy stosować kołki specjalne. O śruby lub kołki odpowiednie dla konstrukcji danej ściany należy pytać w sklepach specjalistycznych. Producent nie ponosi odpowiedzialności za nieprawidłowy montaż i wyniki z tego tytułu szkody. Wszystkie śruby należy regularnie sprawdzać i dokręcać.</p>
ESP	<p>Advertencia: En el caso de incluirse tacos y tornillos con la mercancía, estos están previstos únicamente para su uso en paredes macizas y homogéneas a fin de evitar un posible vuelco. Antes de taladrar, asegúrese de que por el punto de perforación no pasan tuberías de gas o agua o cables eléctricos. Para la fijación en otro tipo de paredes deben utilizarse tacos especiales. Pregunte en la tienda por los tornillos o tacos adecuados para las características de la pared en cuestión. El fabricante no asume ninguna responsabilidad por un montaje incorrecto ni por los daños resultantes del mismo. Compruebe todos los tornillos en intervalos regulares y apriételes.</p>
CZ	<p>Výstražné upozornění: Pokud jsou k výrobku přiloženy hmoždinky a šrouby, jsou určeny výhradně pro použití do stěn zhotovených z masivních a homogenních materiálů, a to za účelem zajištění proti převrácení. Před vrtáním se ujistěte, že se v místě vrtání nenachází vedení plynu, vody nebo elektřiny. Pro připevnění k jiným stěnám je nutné použít speciální hmoždinky. Informujte se v obchodě o hmoždinkách a/nebo šroubech vhodných pro příslušnou strukturu stěny. Výrobce nenese odpovědnost za nesprávnou montáž a za škody jí způsobené. Všechny šrouby pravidelně kontrolujte a dotahujte.</p>
SK	<p>Informácia o nebezpečenstve: Ak sú k tovaru priložené príchytky a skrutky, sú určené výlučne na použitie na stenách z masívnych a jednotných materiálov, aby sa zabránilo prevráteniu. Pred vrtaním sa uistite, že sa na vrtanom mieste nenachádzajú žiadne plynové, vodovodné alebo elektrické vedenia. Na upevnenie na iných stenách musia byť použité špeciálne príchytky. Spýtajte sa v predajni na skrutky a/alebo príchytky vhodné pre príslušný typ steny. Výrobca nepreberá rúčenie za nesprávnu montáž a tým vzniknuté škody. Všetky skrutky v pravidelných intervaloch kontrolujte a dotiahnite.</p>
HU	<p>Figyelmeztetés: Amennyiben a termék csomagolásá tipliket és csavarokat is tartalmaz, azok kizárólag masszív, egységes anyagból készült falakon használhatók, a felborulás megakadályozásának céljából. A fúrás előtt bizonyosodjon meg arról, hogy a fúrás helyén nem található gáz-, víz- vagy elektromos vezeték. Egyéb falakra történő rögzítéshez speciális tiplik szükségesek. Az egyes faltípusokkal használható megfelelő csavarokkal és/vagy tiplikkel kapcsolatos információkért kérjük, forduljon forgalmazójához. A nem szakszerű szerelésért és az abból keletkező károkért a gyártót semmilyen felelősség nem terheli. Minden csavart ellenőrizzen és rögzítsen rendszeresen.</p>
BG	<p>Предупредително указание : Ако в окомплектовката на доставката на стоката са включени дюбели и винтове, те са предназначени единствено за употреба върху стени от масивни и еднородни материали, за да се предотврати преобръщане. Преди пробиване се уверете, че на мястото на пробиване няма тръби за газ, за вода или електрически проводници. За закрепване към други стени трябва да се използват специални дюбели. Информирайте се в търговската мрежа относно подходящите винтове и/или дюбели за съответната конструкция на стената. Производителят не поема отговорност за неправилен монтаж и възникнали в резултат на това щети. Моля, проверявайте и затягвайте всички винтове на редовни интервали.</p>

TR	Uyarı: Ürün paketinde dübel ve vida varsa, bunlar devrilmeyi önlemek amacıyla, sadece masif ve yekpare malzemelerden imal edilmiş duvarlardaki kullanım için öngörülmüştür. Matkapla delik açmadan önce delme noktasında gaz, su veya elektrik hatlarının olmadığından emin olun. Ürünü başka duvarlara sabitlemek için özel dübeller kullanılmamalıdır. Piyasadaki satıcılardan ilgili duvarın özelliğine uygun vidalar ve dübeller hakkında bilgi alın. Usulüne aykırı bir montaj ve bu nedenle oluşmuş hasarlar için üretici sorumluluk almamaktadır. Lütfen tüm vidaları düzenli aralıklarla kontrol edip tekrar sıkın.
PT	Advertência: Caso o produto venha com buchas e parafusos incluídos, os mesmos são exclusivamente destinados à fixação em paredes de materiais sólidos e uniformes, para evitar que o produto tombe. Antes de iniciar a perfuração, certifique-se de que não existem canalizações de gás, água ou fios elétricos a passar no local dos furos. Para a fixação noutro tipo de paredes, têm de ser utilizadas buchas especiais. Informe-se junto de um comerciante especializado sobre os parafusos e buchas a utilizar na parede específica. O fabricante não assume qualquer responsabilidade no caso de uma montagem inadequada e qualquer dano daí resultante. Verifique e volte a apertar todos os parafusos regularmente.
SI	Opozorilo: če so blagu priloženi zidni vložki in vijaki, so ti namenjeni izključno za uporabo na stenah iz masivnih in enotnih materialov, da se prepreči prevrnitev. Pred vrtnanjem se prepričajte, da na mestu vrtnanja ni plinskih, vodnih ali električnih napeljav. Za pritrditev na druge stene je treba uporabljati posebne zidne vložke. Pozanimajte se v trgovini o vijakih in/ali zidnih vložkih, primernih za posamezno sestavo stene. Proizvajalec ne prevzema jamstva za nepravilno montažo in zaradi tega nastalo škodo. Vse vijake redno preverjajte in naknadno privijajte.
NL	Waarschuwing: Indien er bij het product pluggen en schroeven zijn meegeleverd, zijn deze uitsluitend bestemd om in muren van massieve en homogene materialen te gebruiken om te voorkomen dat het product kantelt. Controleer voordat u begint of er geen gas-, water- of elektriciteitsleidingen lopen waar u gaat boren. Voor de bevestiging aan andere soorten muren moeten speciale pluggen worden gebruikt. Informeer in de winkel welke schroeven en/of pluggen geschikt zijn voor de desbetreffende muur. De fabrikant is niet aansprakelijk voor een onjuiste montage en de daardoor ontstane schade. Controleer regelmatig of alle schroeven nog goed vastzitten en draai ze zo nodig vast.
SRB	Upozoravajuća napomena: Ako su uz robu priloženi tiplovi i zavrtnji, isti su namenjeni isključivo za primenu na zidovima od kompaktnih i homogenih materijala, kako bi se sprečilo prevrtanje. Pre bušenja se uverite da se na mestu bušenja ne nalaze vodovi za gas, vodu ili struju. Za fiksiranje na drugačijim zidovima moraju da se upotrebe specijalni tiplovi. Raspitajte se u trgovini o zavrtnjima i/ili tiplovima koji su adekvatni za dotičnu teksturu zida. Proizvođač ne preuzima nikakvu odgovornost za nestručnu montažu i štete koje su nastale na taj način. Sve zavrtnje kontrolišite i dotežite u redovnim intervalima.
RO	Indicație de avertizare: Dacă produsul este livrat împreună cu șuruburi și dibluri, acestea sunt destinate exclusiv utilizării pe pereții construiți din materiale masive și uniforme, pentru a preveni răsturnarea produsului. Înainte de a realiza găurile, asigurați-vă că nu există conducte de gaz, apă sau electricitate în locul pe care doriți să-l găuriți. Pentru prinderea pe alte tipuri de pereți, trebuie să utilizați dibluri speciale. Interesați-vă la magazinul specializat, pentru a găsi șuruburile și/sau diblurile potrivite pentru peretele dvs. Producătorul nu este responsabil, în cazul unui montaj necorespunzător pentru daunele rezultate. Vă rugăm să verificați toate șuruburile la intervale regulate și să le strângeți.
HR	Upozorenje: Ako su uz proizvod priložene tiple i vijci, oni su namijenjeni isključivo za korištenje na zidovima od čvrstih i jednoličnih materijala kako bi se spriječilo prevrtanje. Prije bušenja provjerite da na mjestu bušenja nema električnih vodova, plinskih ili vodovodnih cijevi. Za pri čvršćivanje na ostale zidove potrebno je koristiti posebne tiple. Prilikom kupnje raspitajte se kod svog prodavača o vijcima i tiplama koji su prikladni za odgovarajuću zidnu strukturu. Proizvođač ne odgovara za štete nastale uslijed nepravilne montaže. Sve vijke potrebno je redovito provjeravati i zategnuti.
SE	Varning: Om plugg och skruvar följer med produkten är de endast avsedda för väggar av massivt och enhetligt material för att förhindra att produkten vippar. Försäkra dig om att inga gas-, vatten- eller elledningar befinner sig på platsen som du ska borra innan du börjar. För fastsättning i väggen måste specialplugg användas. Informera dig i en butik om vilka skruvar och plugg som passar till vilken vägg. För en felaktig montering och skador som uppstår på grund av detta tar tillverkaren inget ansvar. Kontrollera och dra åt alla skruvar med jämna mellanrum.
RUS	Предупреждение : Если изделие поставляется вместе с дюбелями и шурупам, они предназначены исключительно для использования на стенах из монолитных и однородных материалов, чтобы предотвратить возможное обрушение. Перед началом сверления убедитесь, что на месте сверления нет газопровода, водопровода или электропроводки. Для крепления к другим стенам необходимо использовать специальные дюбели. Узнайте у продавца, какие шурупы или дюбели подходят для соответствующей структуры стены. Производитель не несет ответственности за неправильный монтаж и вызванный им ущерб. Регулярно проверяйте и подтягивайте все шурупы .
UKR	Попередження : Якщо до виробу додаються дюбелі та гвинти, вони призначені виключно для використання на стінах з цільних й однорідних матеріалів, щоб не допустити перекидання.. Перед сверлінням переконайтеся, що на місці сверління немає ліній газу,- водопостачання чи електропроводки. Для кріплення до інших стін необхідно використовувати спеціальні дюбелі. Запитайте продавця, які гвинти та/або дюбелі підходять для стіни з відповідною структурою. Виробник не несе відповідальності за неправильний монтаж та збитки, що виникли внаслідок цього. Перевіряйте та підтягуйте всі гвинти через регулярні проміжки часу .
LT	Įspėjimas: jei prie prekės pridėtos mūrvinės ir varžtai, jie skirti naudoti tik ant sienų, pagamintų iš tvirtų ir vienodų medžiagų, kad būtų galima išvengti apvirtimo. Prieš gręždami įsitinkite, kad gręžiamoje vietoje nėra dujotiekio, vandentiekio ar elektros linijų. Tvirtinant prie kito tipo sienų reikia naudoti specialias mūrvines. Teiraukitės pardavėjo atitinkamai sienos konstrukcijai tinkamų varžtų ir (arba) mūrvinių. Gamintojas neprisiima atsakomybės dėl netinkamo montavimo ir dėl to atsiradusios žalos. Visus varžtus reguliariai tikrinkite ir priveržkite.
LV	Brīdinājums: Ja precei ir pievienoti dībeļi un skrūves, prece ir paredzēta izmantošanai tikai uz sienām, kas izgatavotas no cietiem un viendabīgiem materiāliem, lai novērstu apgāšanos. Pirms urbšanas pārlicinieties, ka urbšanas vietā nav gāzes, ūdens vai elektropārvades līniju. Lai piestiprinātu pie citām sienām, jāizmanto speciāli dībeļi. Jautājiet savam izplatītājam par skrūvēm un/vai dībeļiem, kas ir piemēroti attiecīgajai sienas konstrukcijai. Ražotājs neuzņemas atbildību par nepareizu montāžu un no tās sekojošajiem bojājumiem. Lūdzu, regulāri pārbaudiet un pievelciet visas skrūves.
EE	Hoiatus! Kui tootele on kaasa pandud tüüblid ja kruvid, on need mõeldud kasutamiseks üksnes massiivsest ja ühtsest materjalist seintel, vältimaks ümberkukkumist. Veenduge enne puurimist, et puurimiskohas ei oleks gaasi- või veetorusid ega elektrijuhtmeid. Seintele kinnitamiseks tuleb kasutada spetsiaalseid tüüpleid. Uurige kaubandusvõrgust, millised kruvid ja/või tüüblid konkreetselt seina jaoks sobivad. Tootja ei võta endale mittenõuetekohasest paigaldamisest tingitud kahjude eest mingit vastutust. Kontrollige ja järelpingutage kõiki kruvisid regulaarselt.



LE TRI
+ FACILE



FR

Donnez ou recyclez
vos meubles.



Association

ou



Magasin

ou



Déchèterie

<https://quefairedemesdechets.fr>