

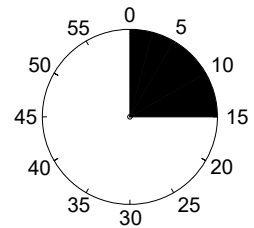

528 azb

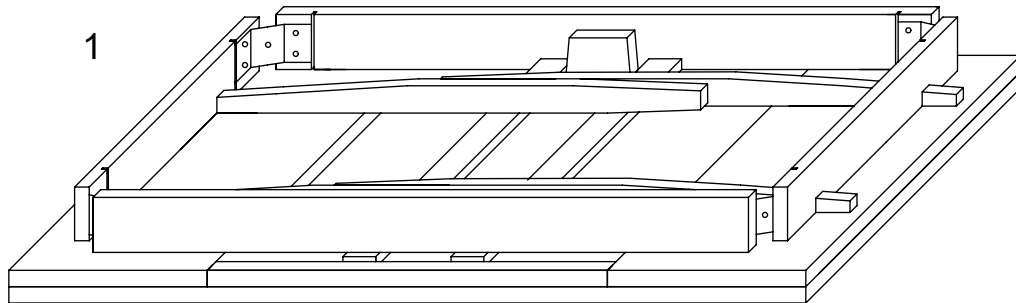
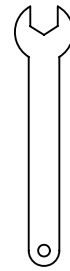
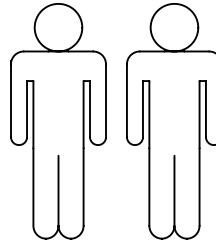
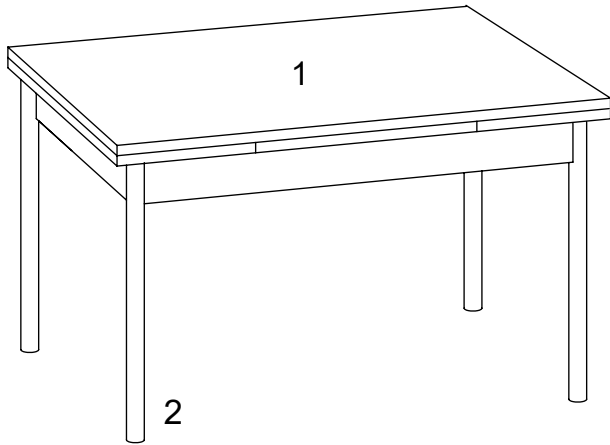

1	1x
2	4x

A	 4x	B	 4x				

1.

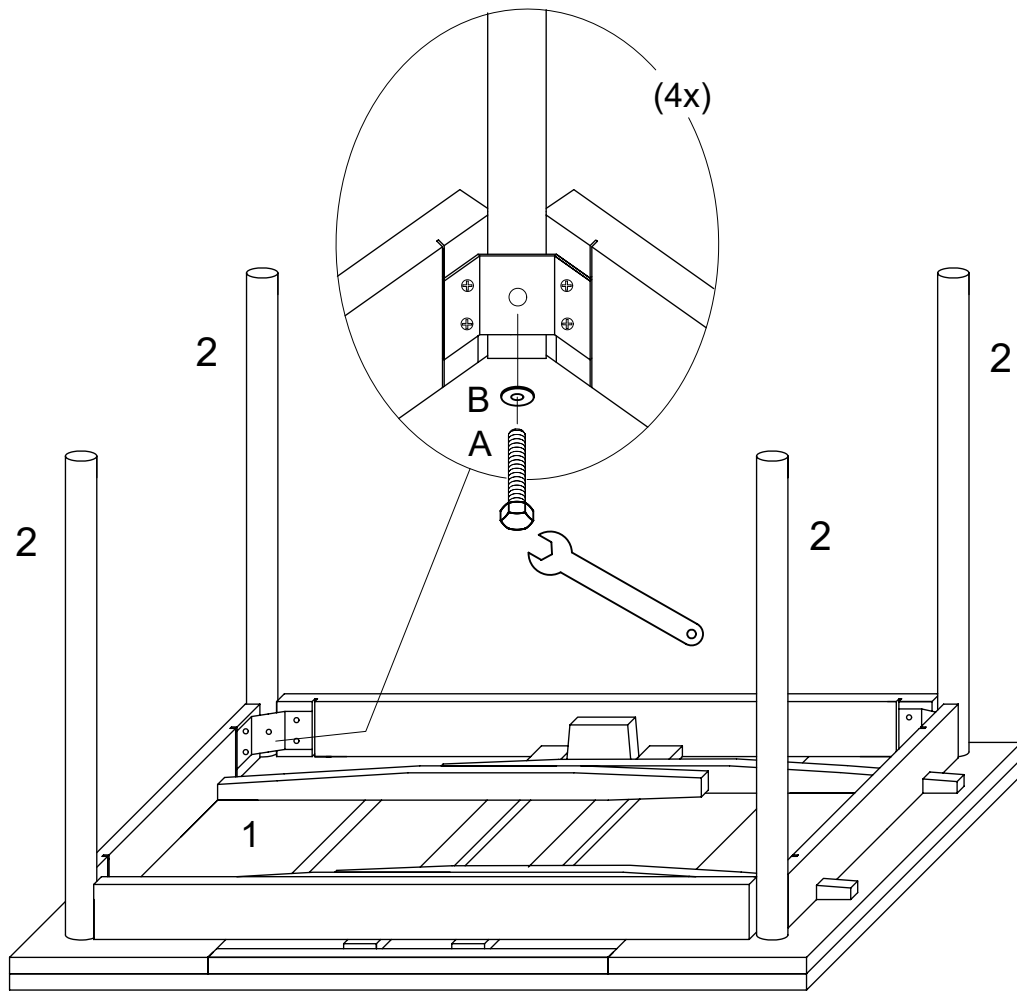

2.

