

60 LO-2100

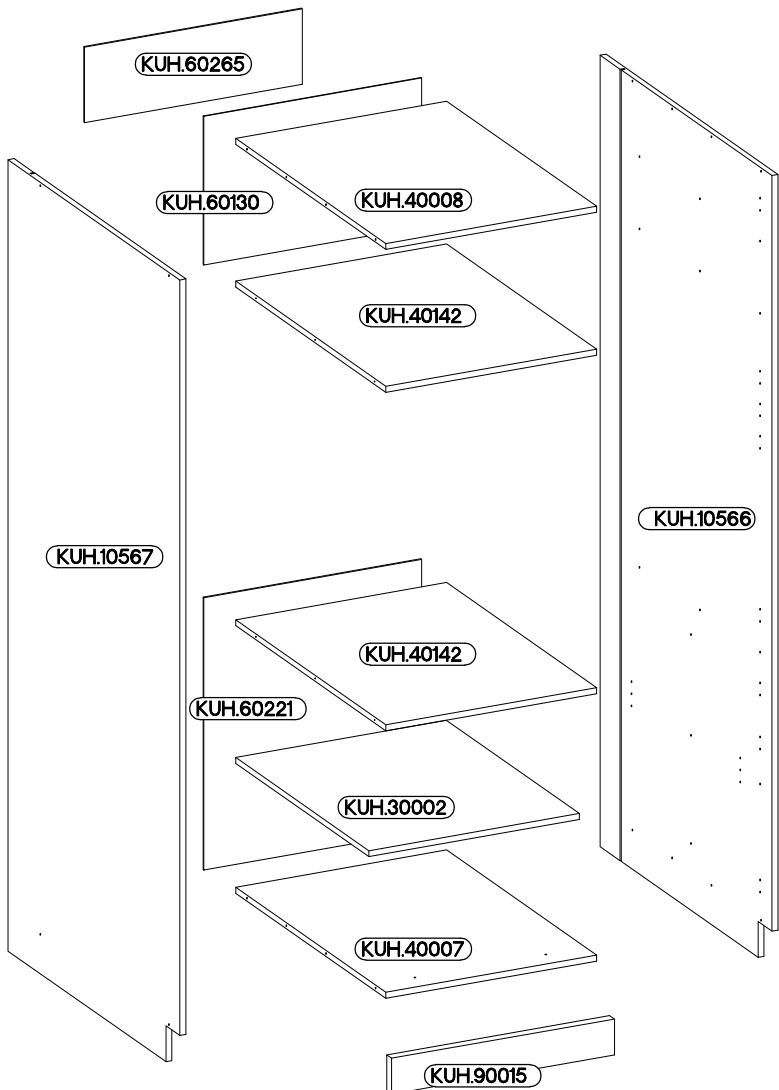

Ersatzteil Nummer	Dimension
KUH.10566	2095x555x16
KUH.10567	2095x555x16
KUH.30002	566x430x16
KUH.40007	567x485x16
KUH.40008	567x485x16
KUH.40142 x2	567x485x16
KUH.60130	393x585x2,5
KUH.60221	721x585x2,5
KUH.60265	200x585x2,5
KUH.90015	599x95x16

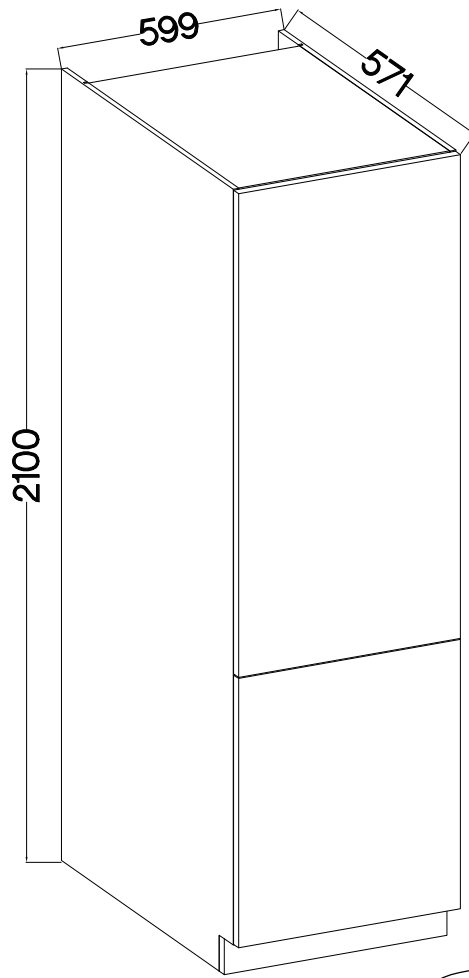
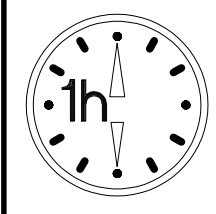
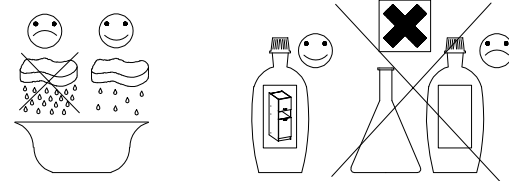

†8x30mm	6,4 x 50mm	†15/12mm
A	B	C
8	8	12

L=20mm				6.5x48x16	†35/0mm	†5/19mm
D2	E	E1	E9	F2	HG	J
12	12	8	2	4	5	4
		†4.0x16mm	†4.0x45mm	†3.5x13mm	†3.0x20mm	
L25	O	P1	P4	P5	P7	T4
1	1	16	2	12	15-20	4

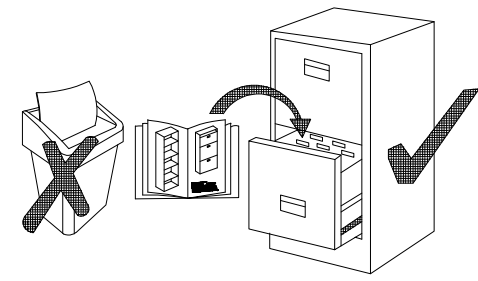

ISM-KUH-01996

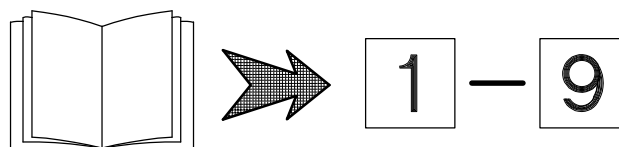
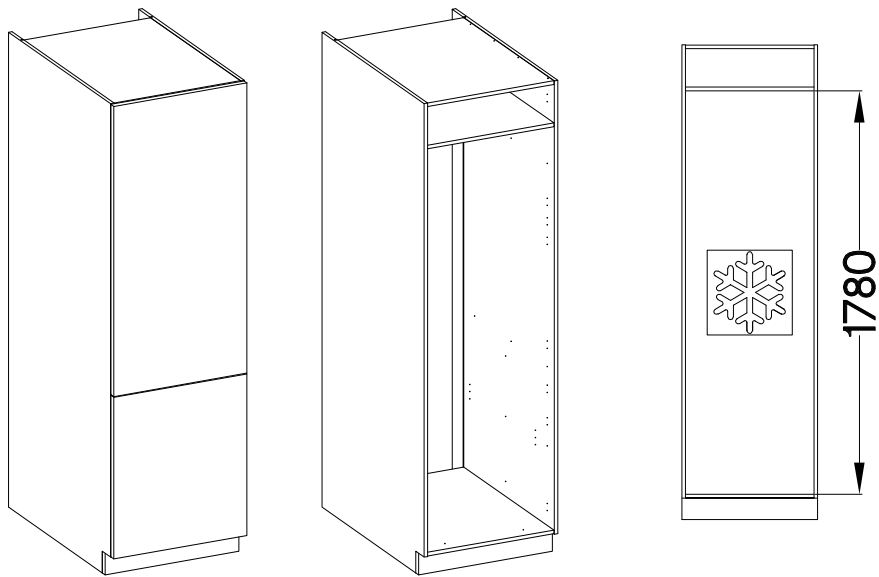



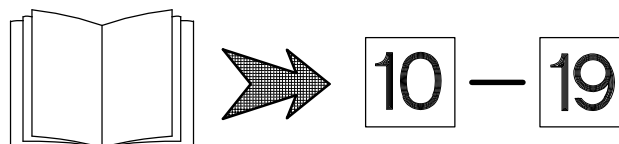
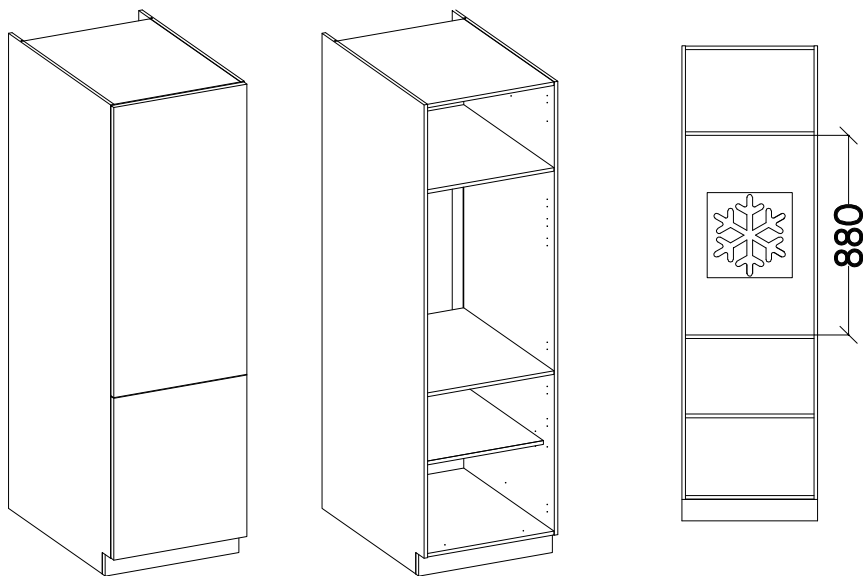

WARIANT B

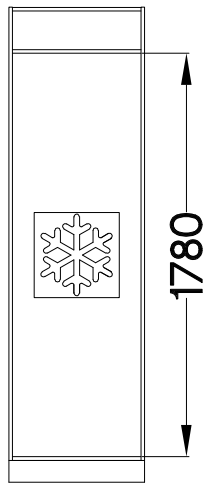
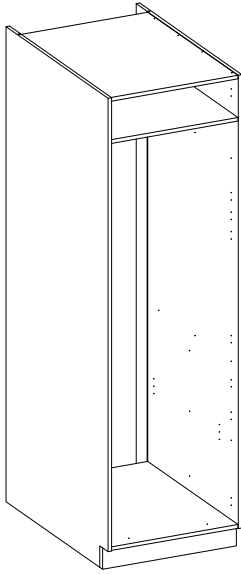

1

WARIANT A



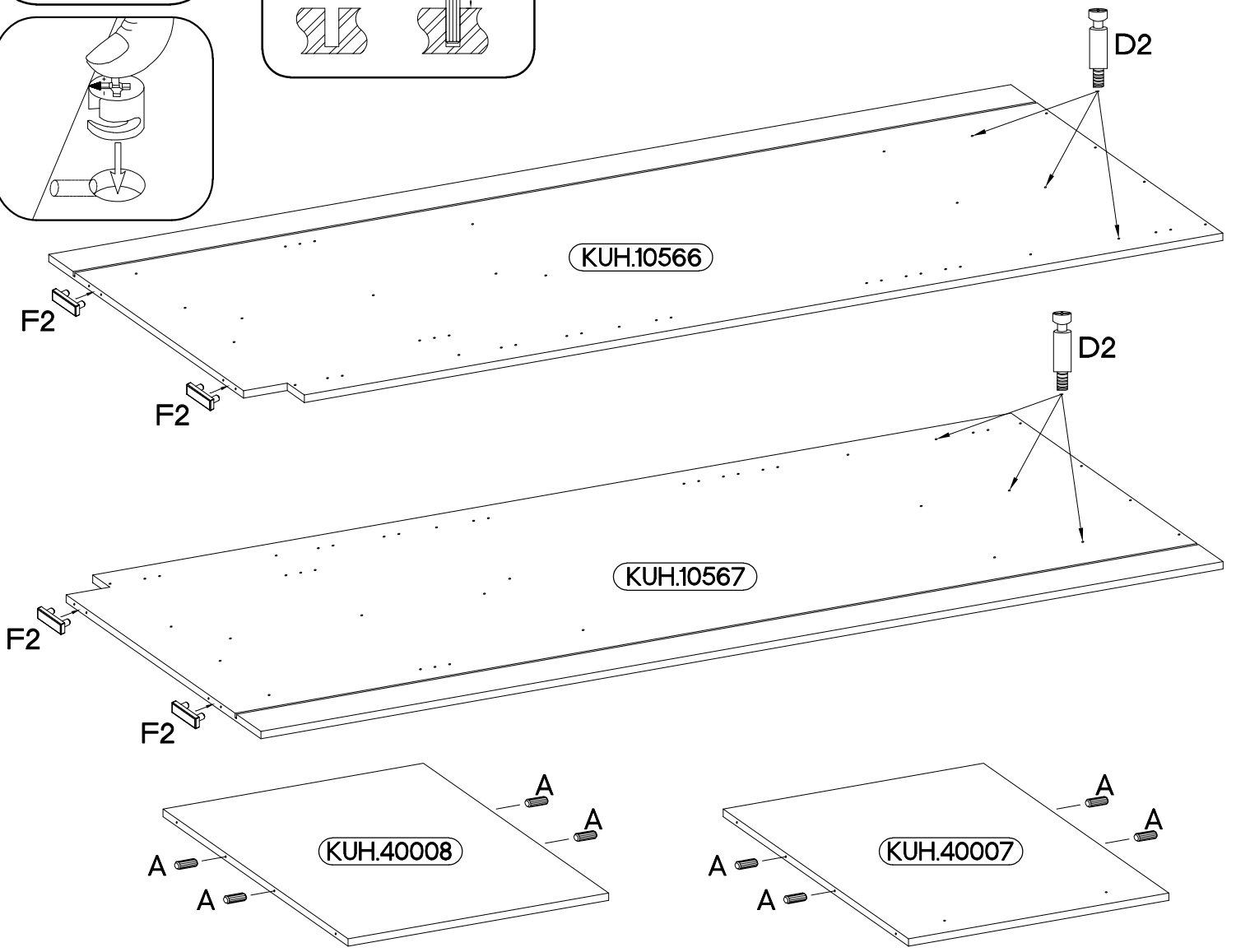
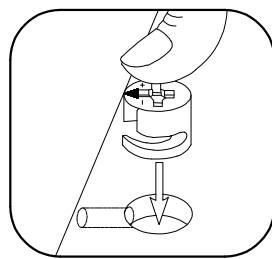
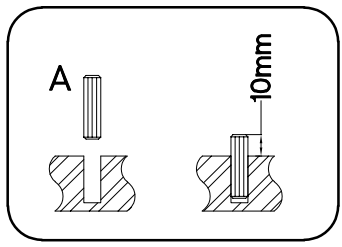
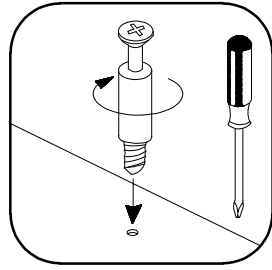
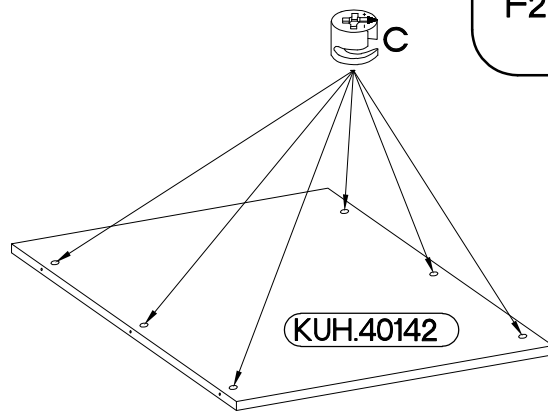
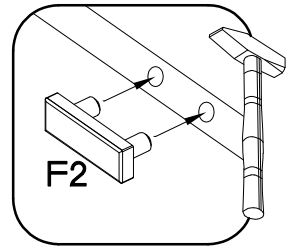
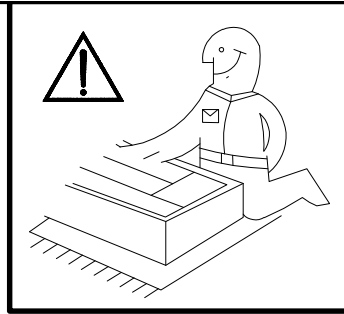

$\varnothing 8 \times 30 \text{mm}$  A	$6.5 \times 48 \times 16$  F2
8 L=20mm  D2	4 $\varnothing 15 / 12 \text{mm}$  C
6	6

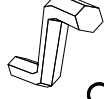

2

6,4 x 50mm

		
B	O	E1
4	1	4

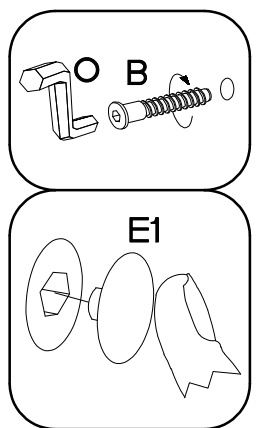
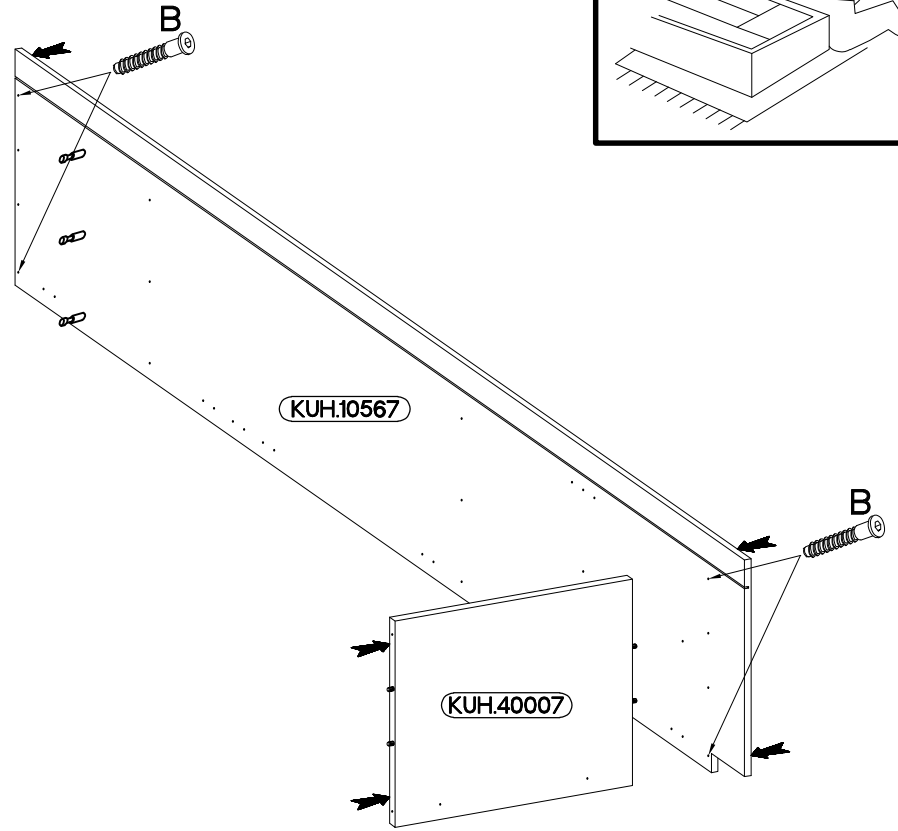
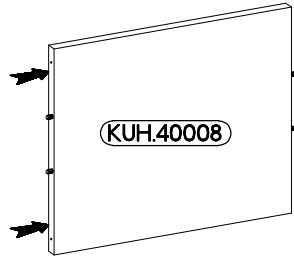
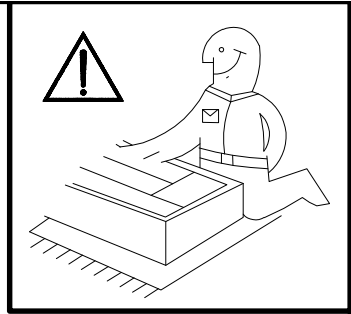

3

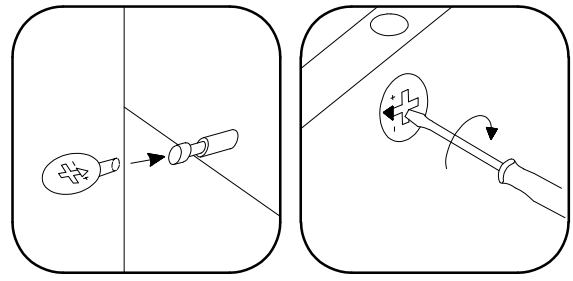
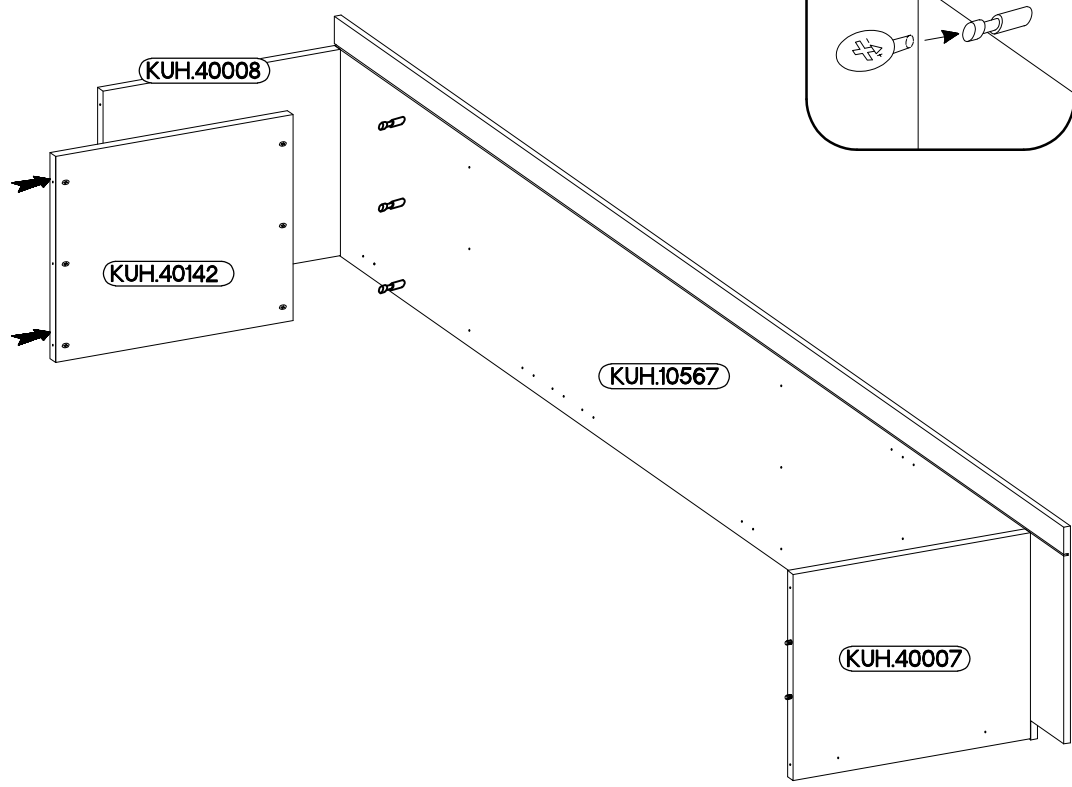

4

6,4 x 50mm				
4	B	O	E1	E
			4	6

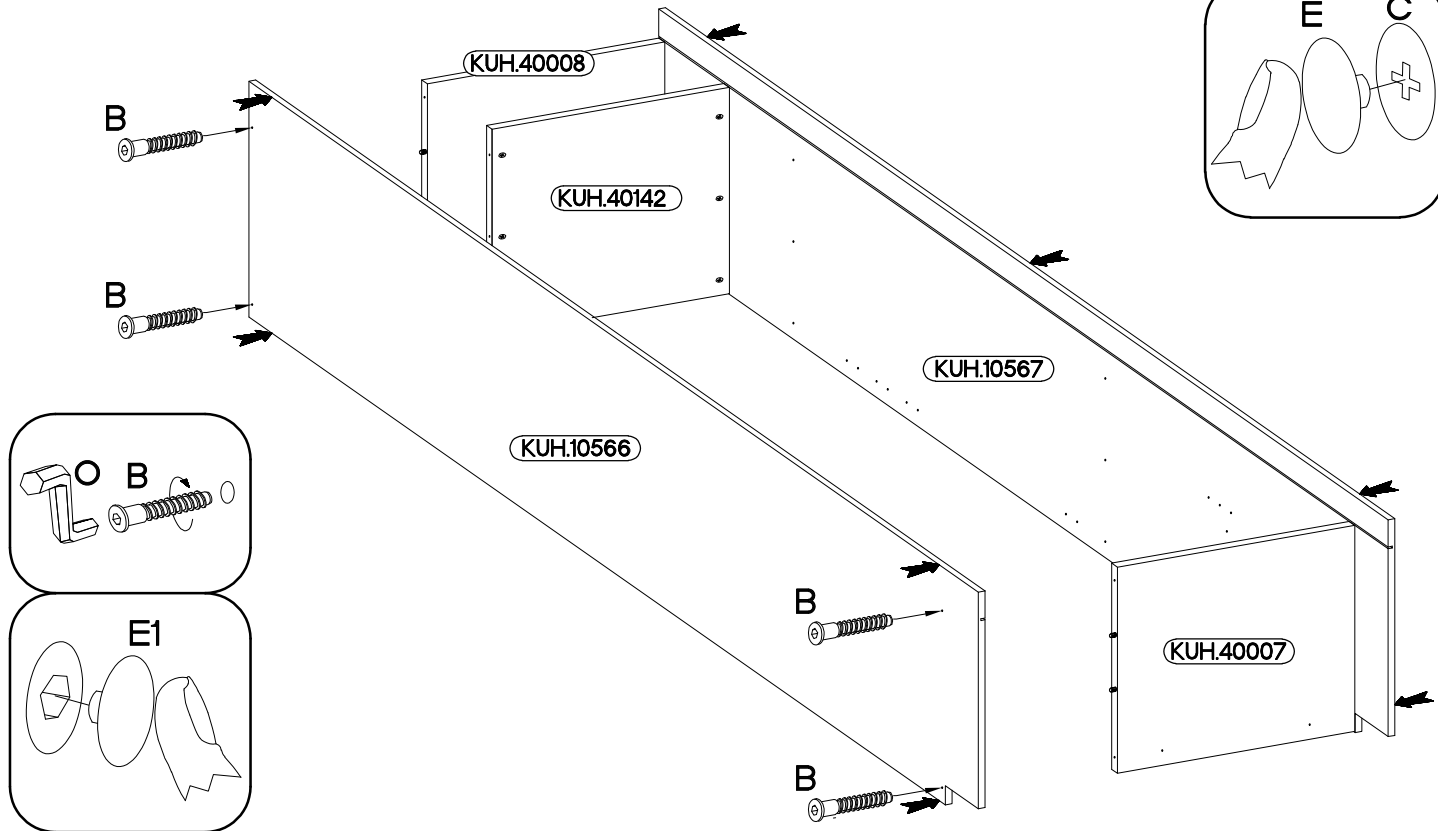
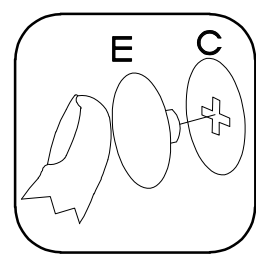
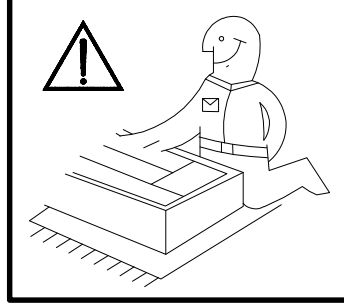
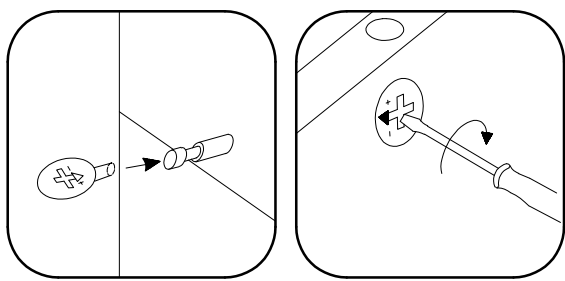

5

T4	P1
4	16

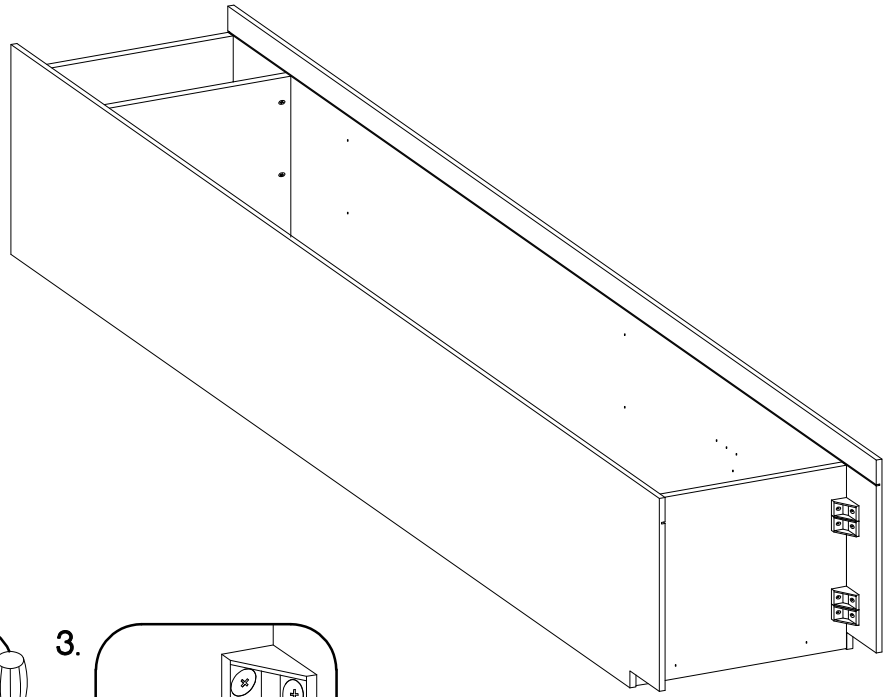
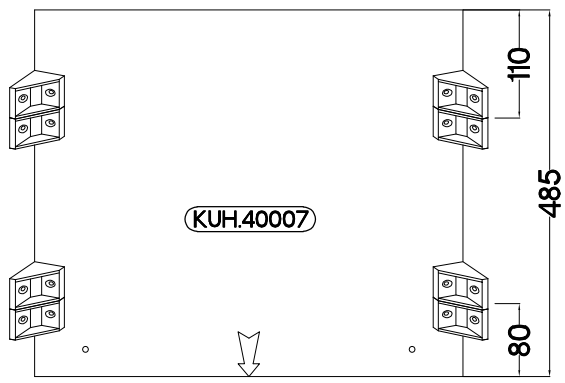



-
-
-

6

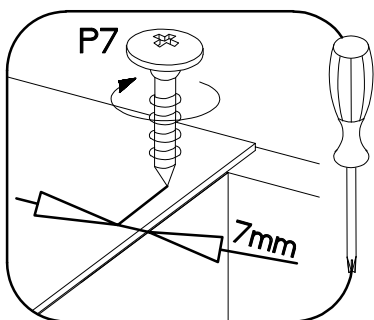
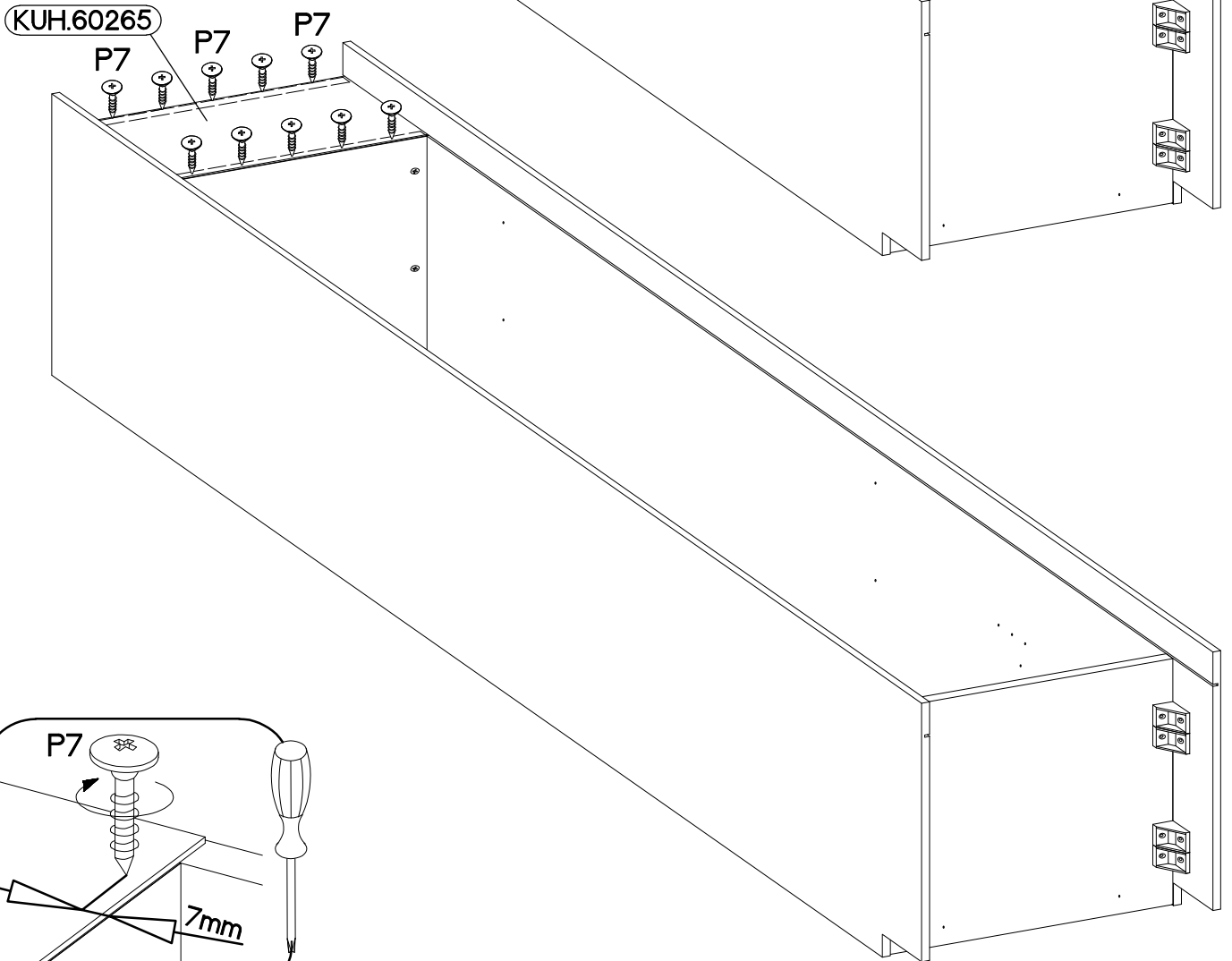
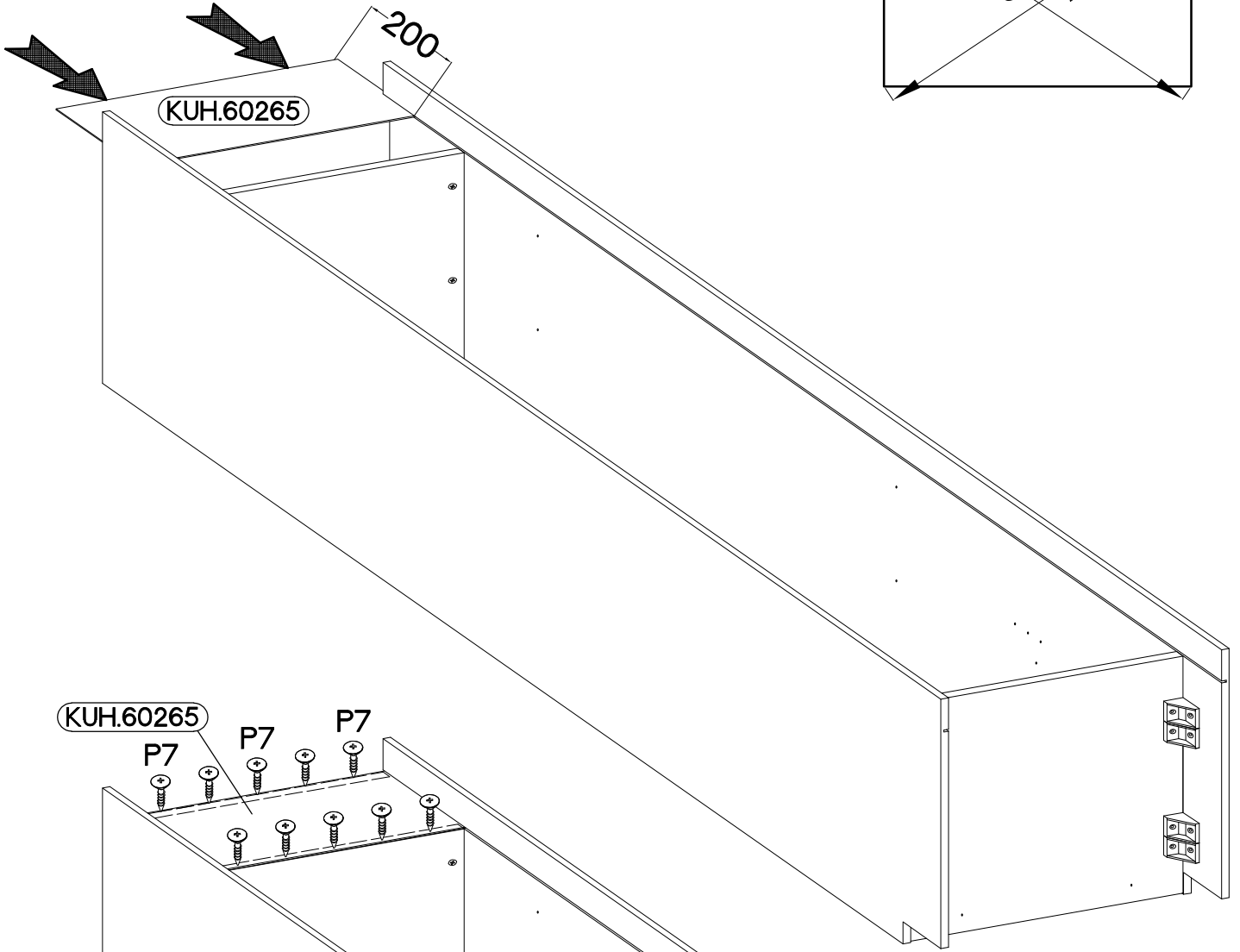
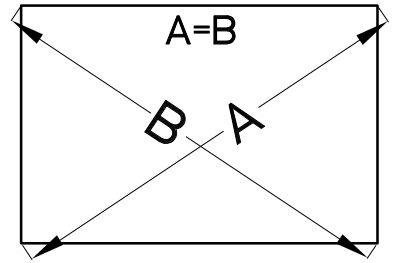
φ3.0x20mm
P7
8-10

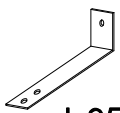

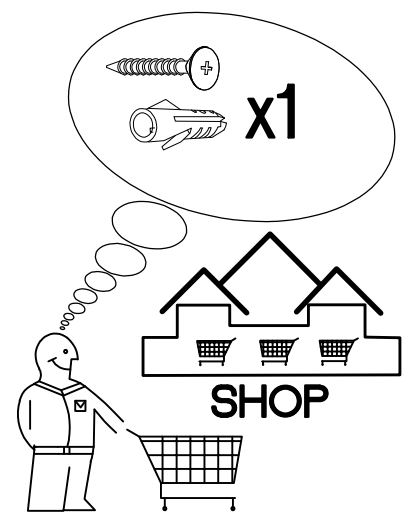
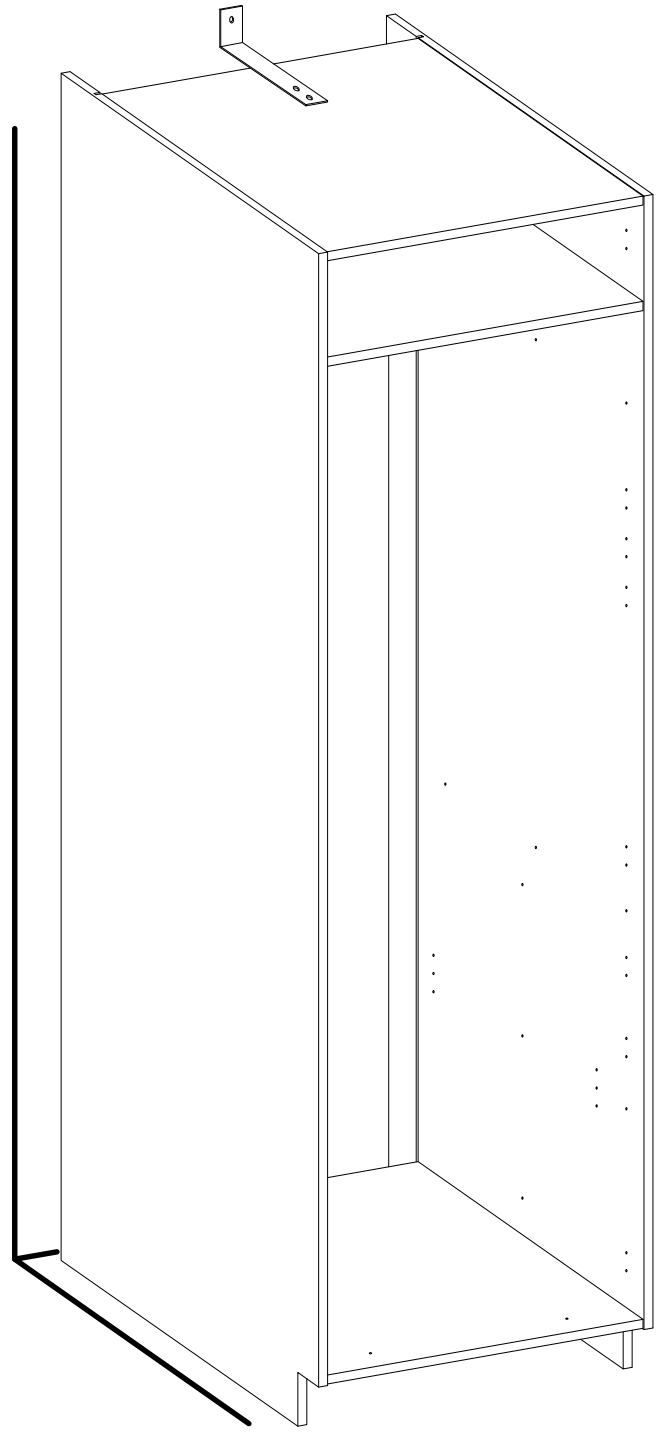
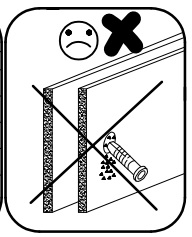
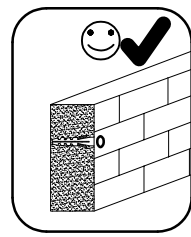
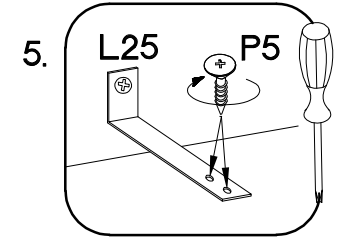
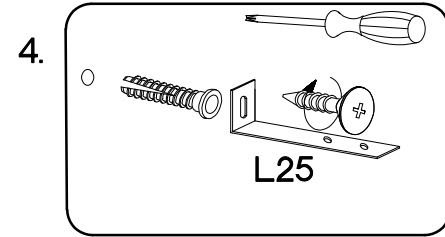
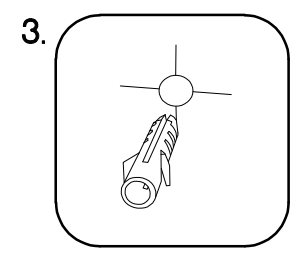
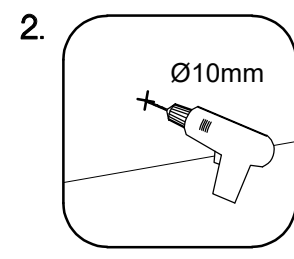
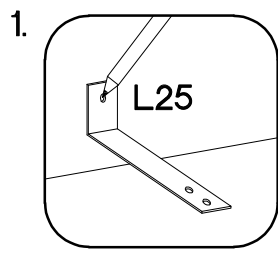

	±3.5x13mm 
L25	P5
1	2

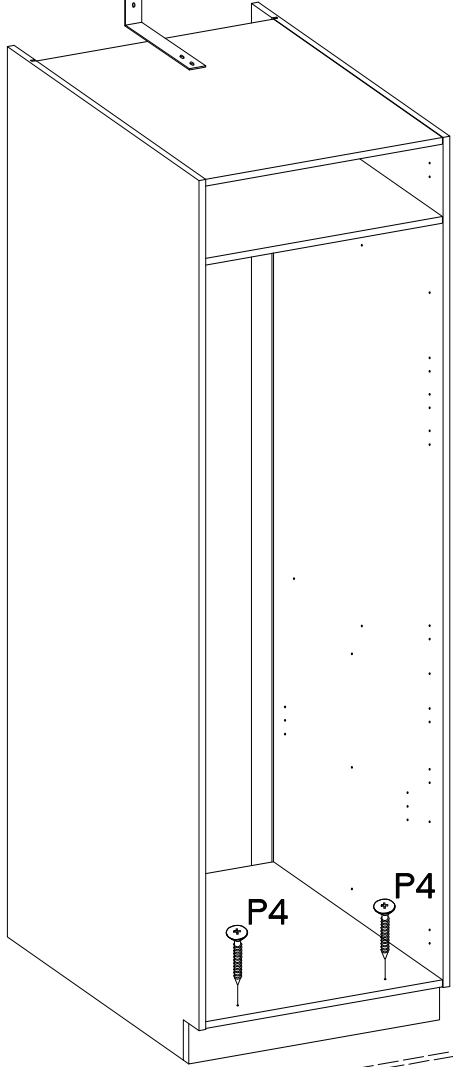

8



4.0x45mm  P4	 E9
2	2

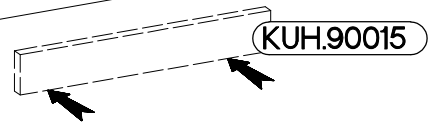
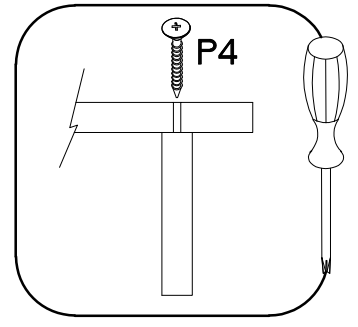

9

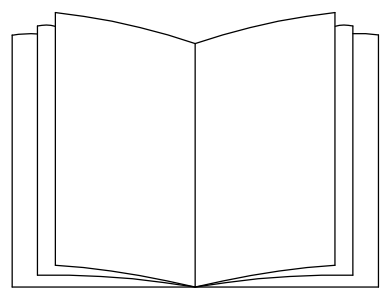
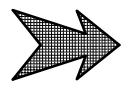
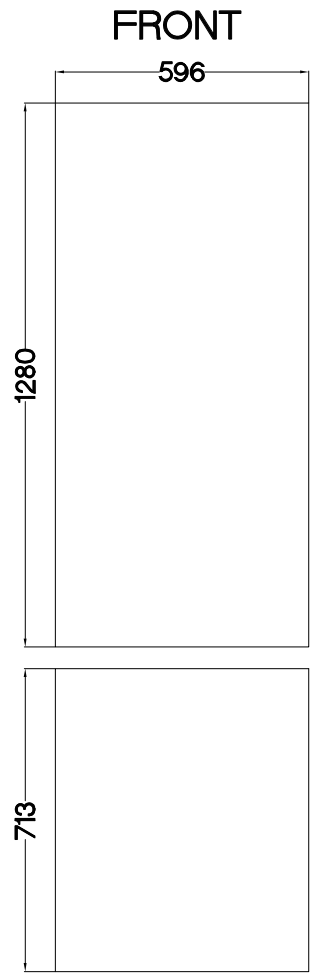
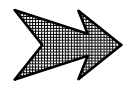
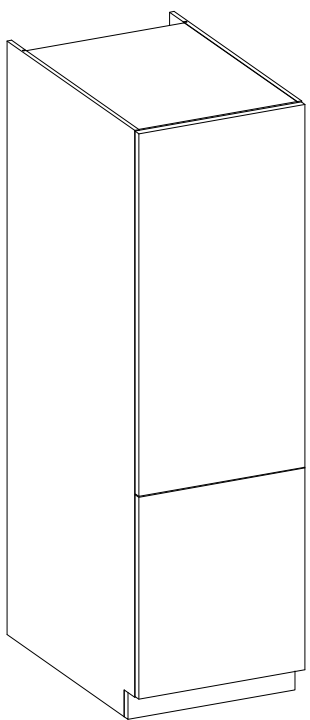

WARIANT B

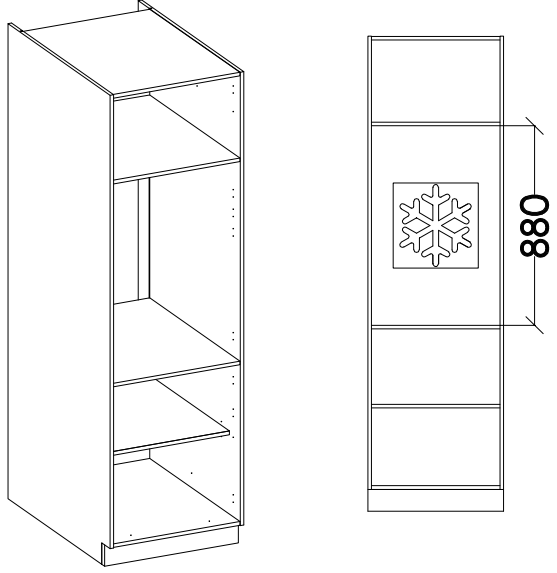

$\varnothing 8 \times 30 \text{mm}$ A	$6.5 \times 48 \times 16$ F2
8 L=20mm D2	4 $\varnothing 15 / 12 \text{mm}$ C
12	12

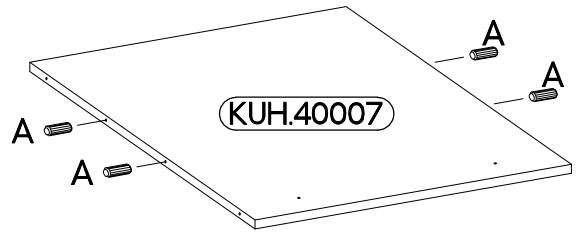
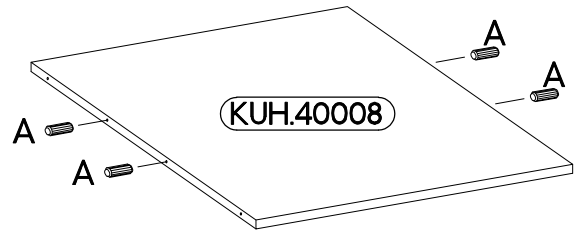
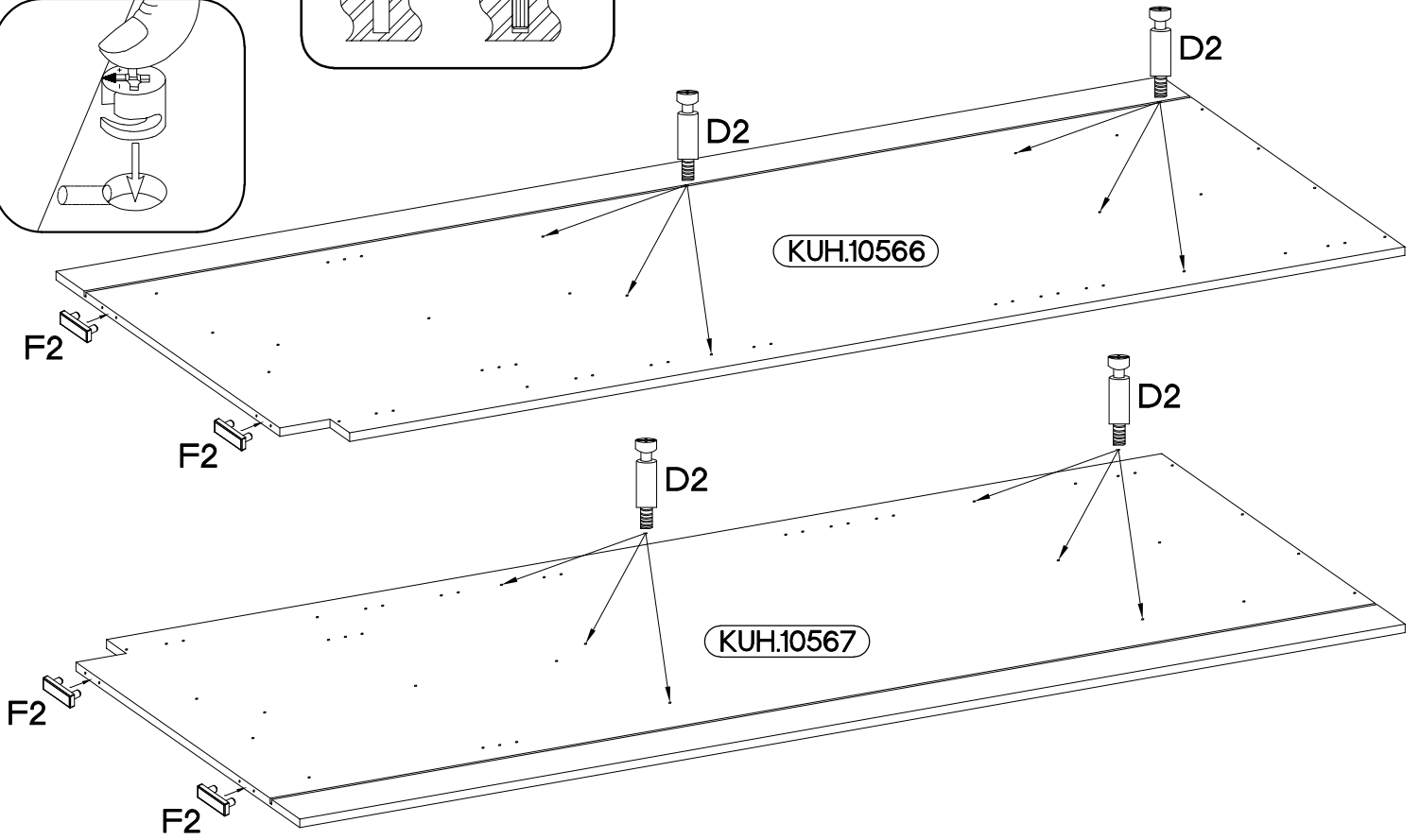
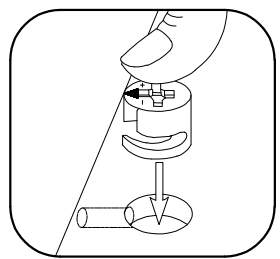
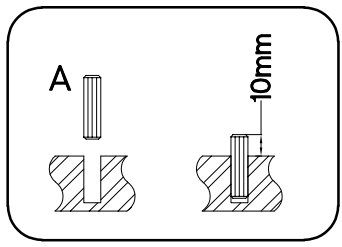
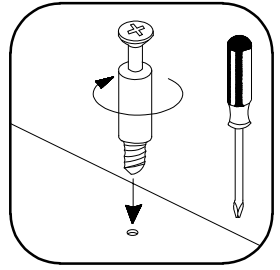
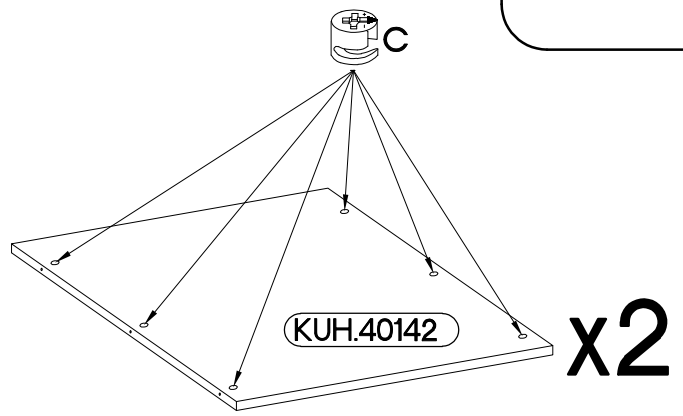
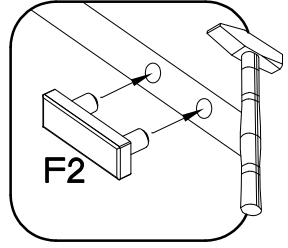
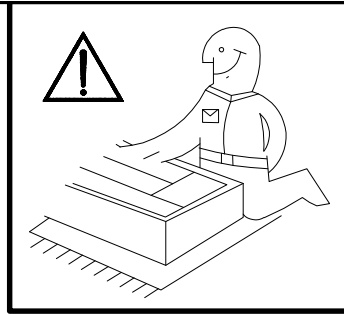

11

6,4 x 50mm

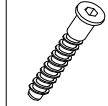

B

4



O

1



E1

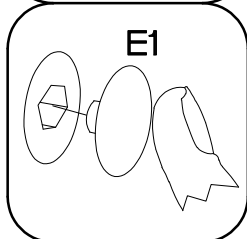
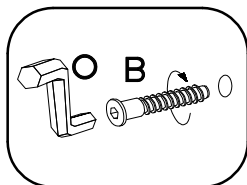
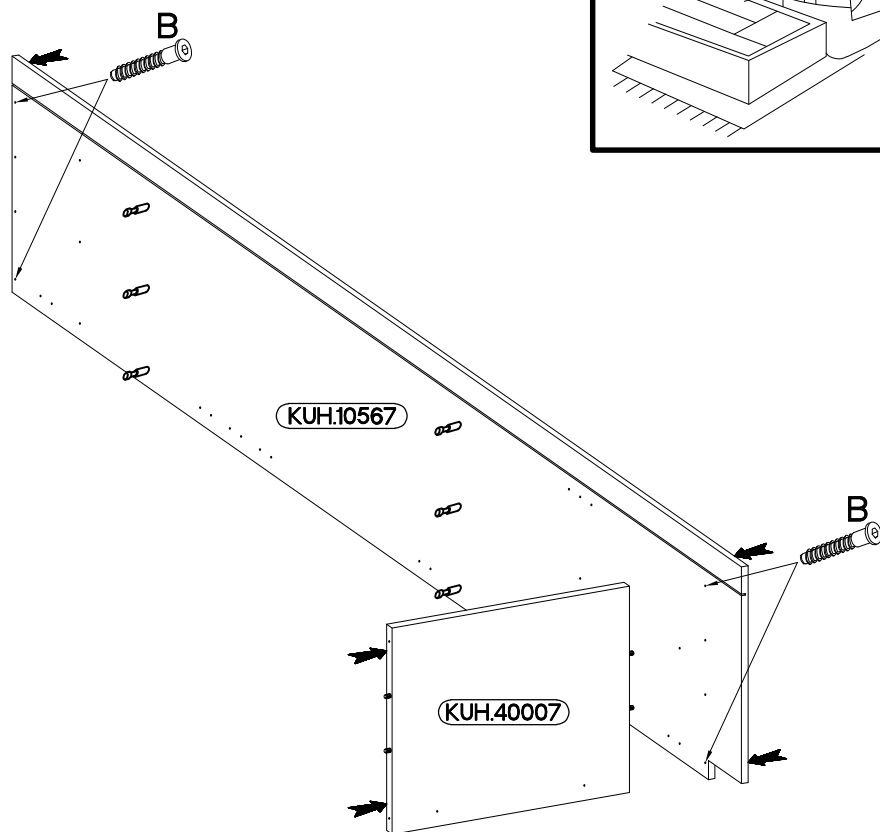
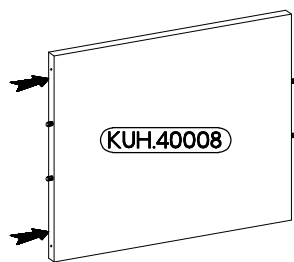
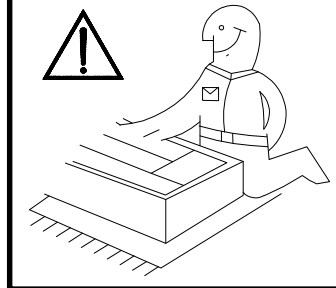

4

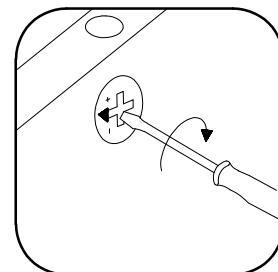
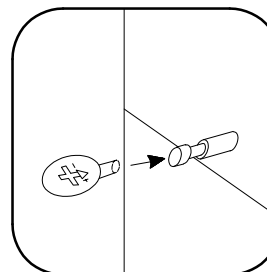
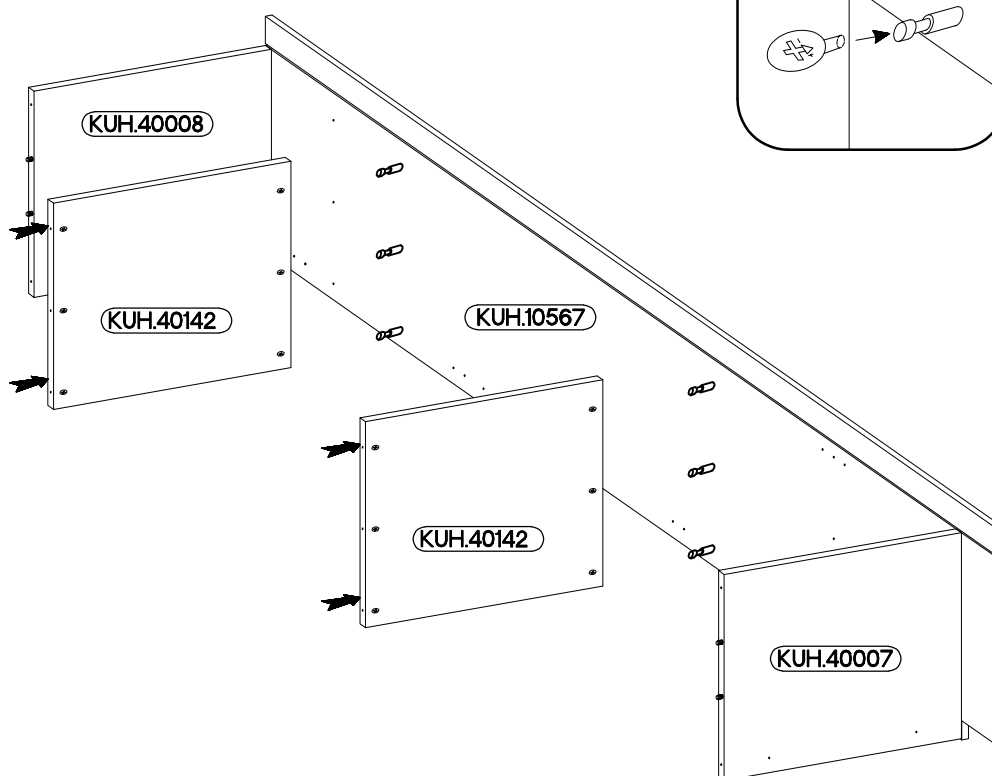

12



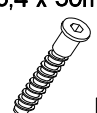
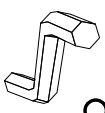

13

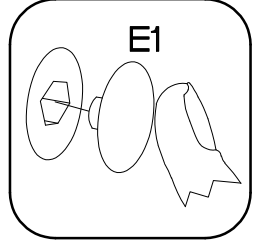
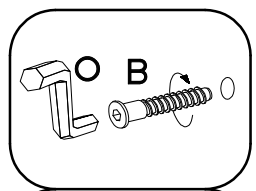
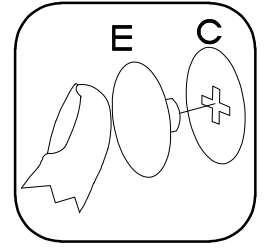
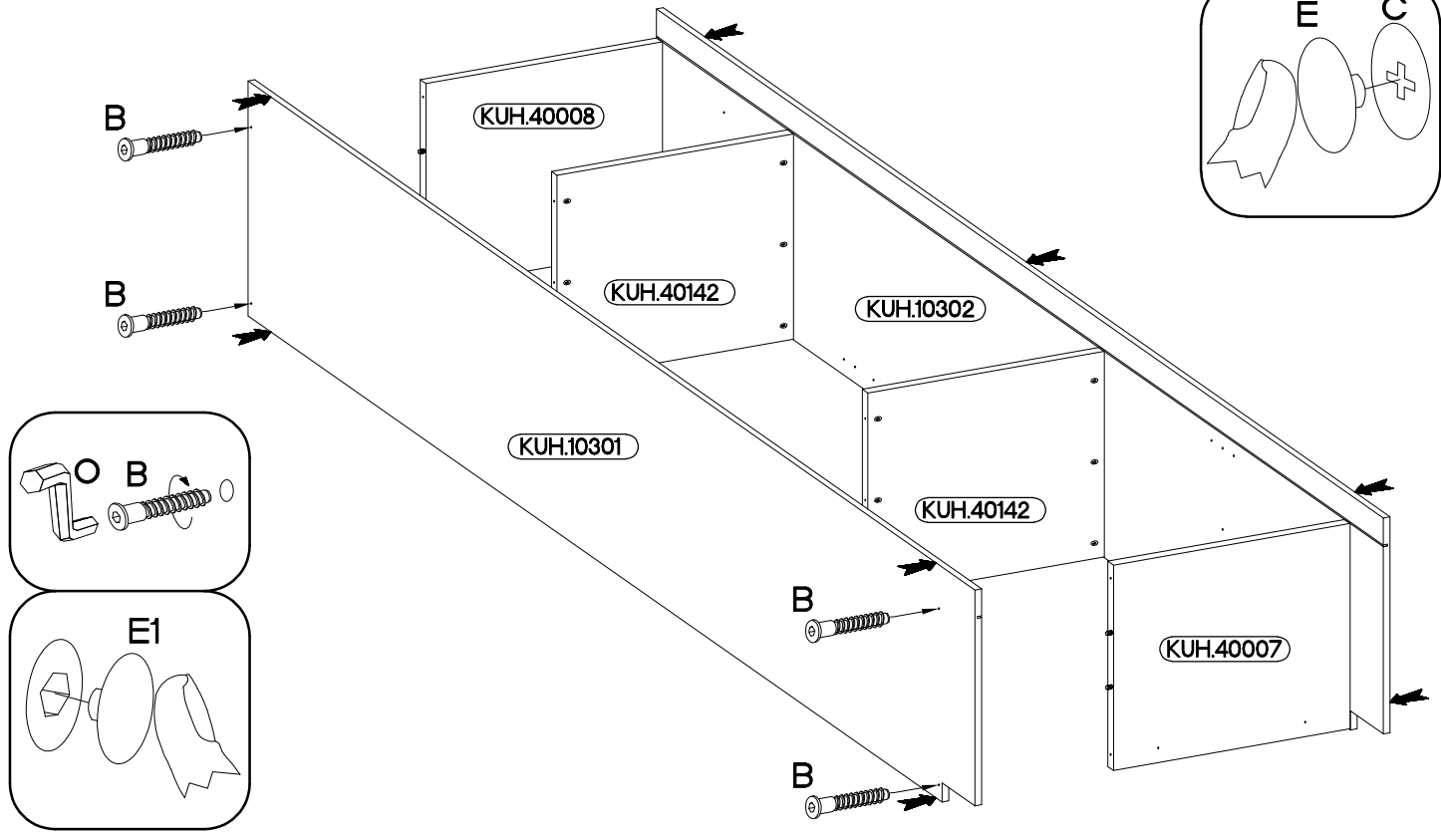
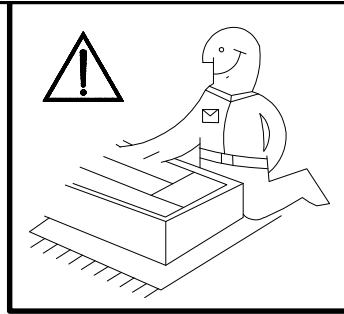
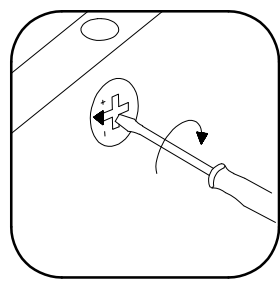
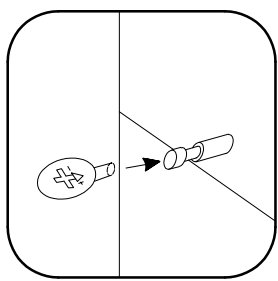
6,4 x 50mm			
			
B	O	E1	E
4	1	4	12



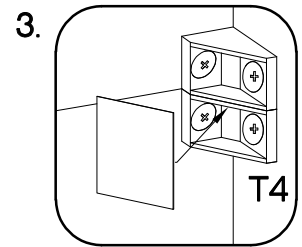
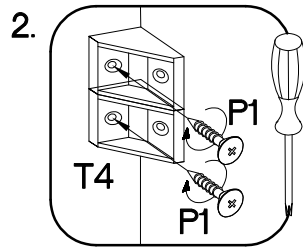
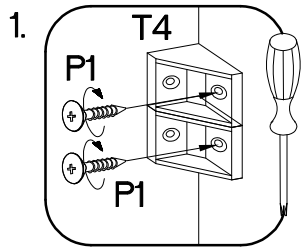
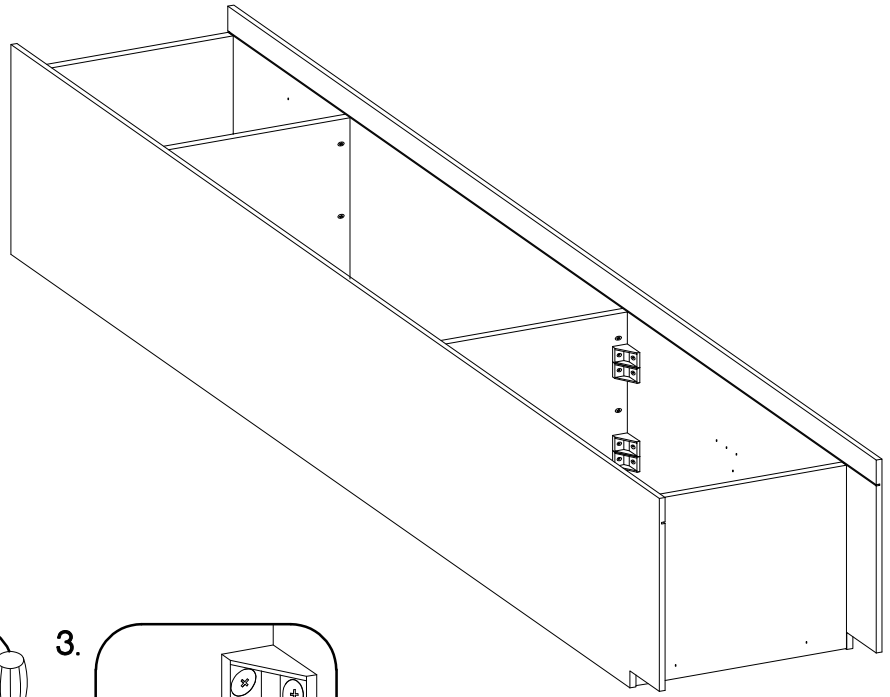
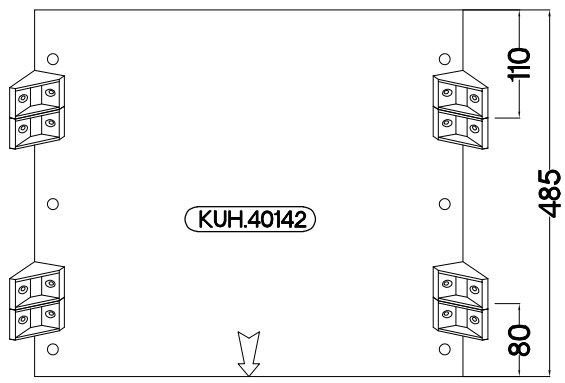

14

	
T4	P1
4	16



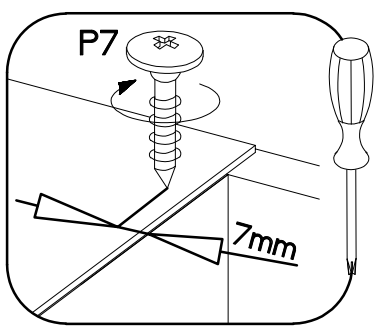
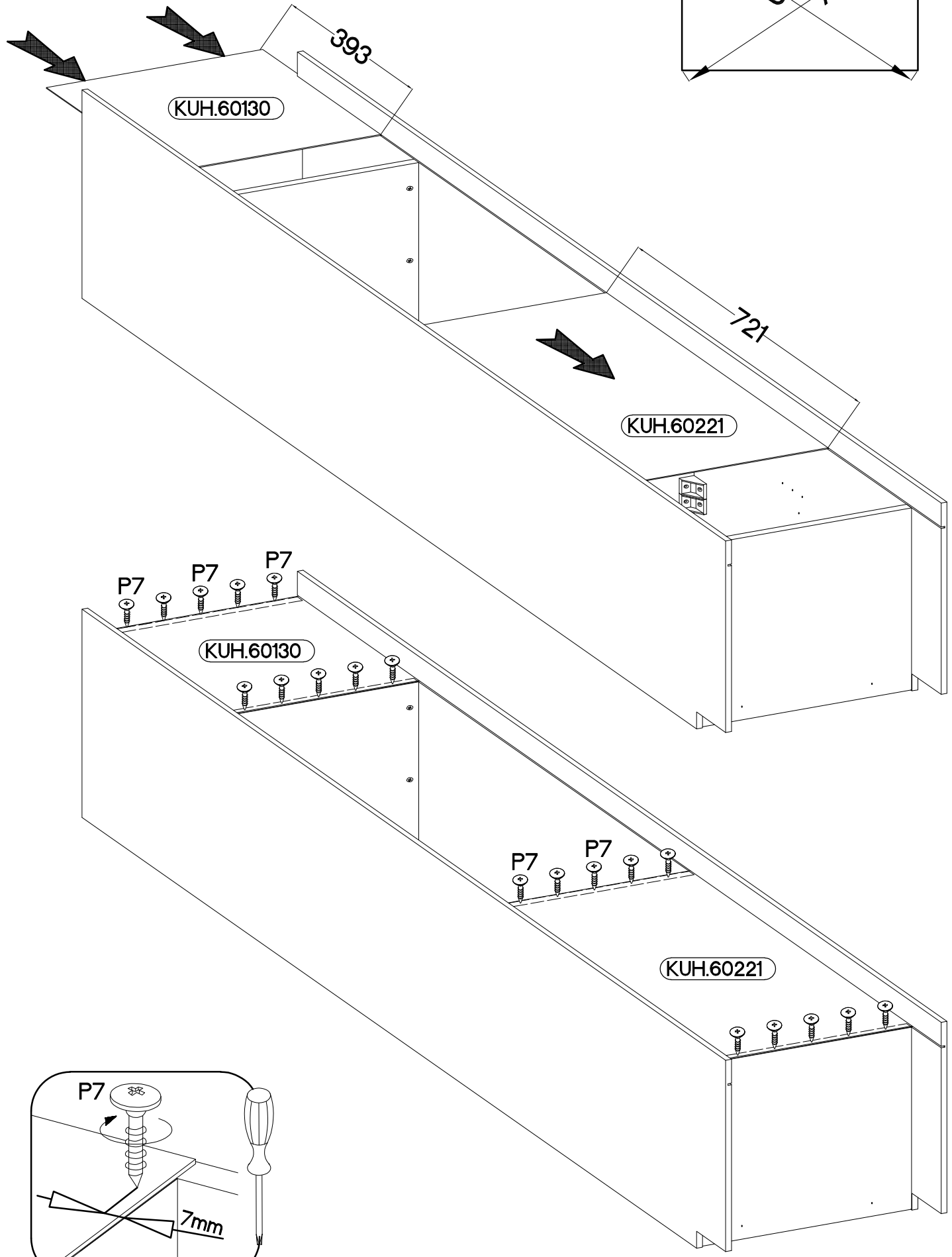
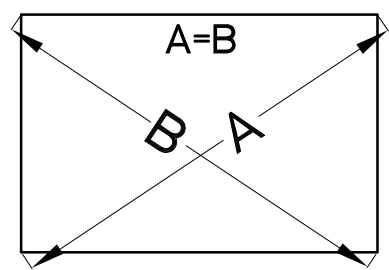

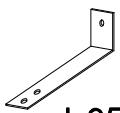
3.0x20mm
P7
15-20

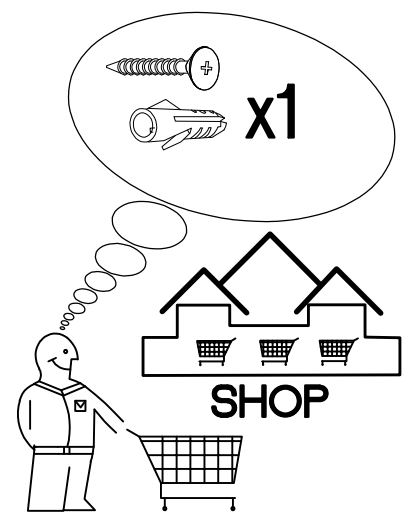
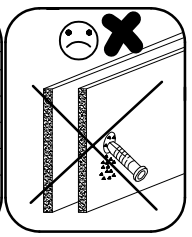
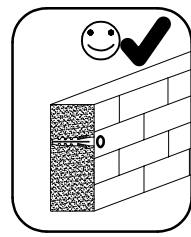
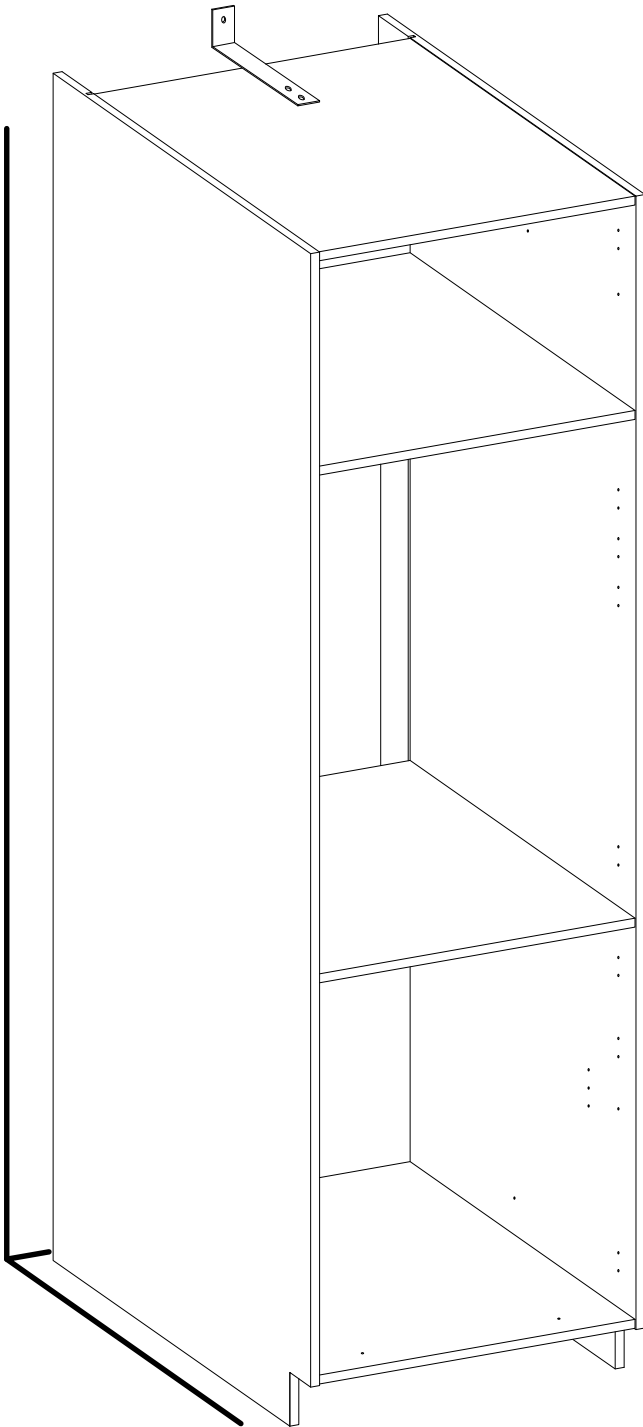
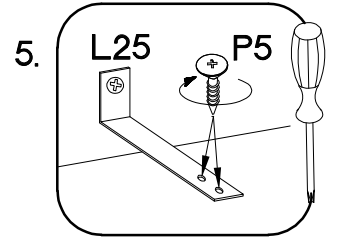
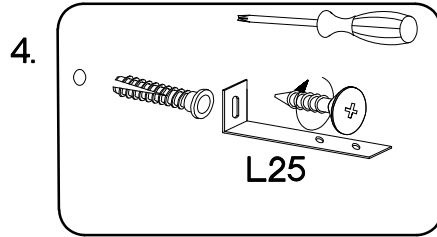
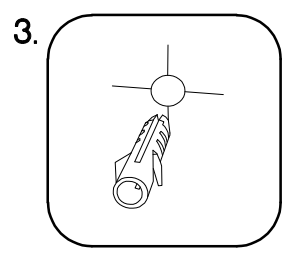
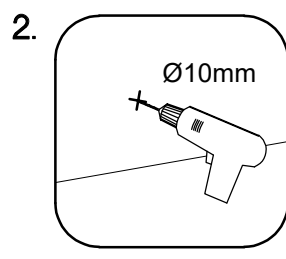
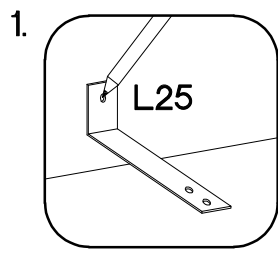

 L25 1	 +3.5x13mm P5 2
--	--



17

<p>±4.0x45mm</p>  <p>P4</p> <p>2</p>	 <p>E9</p> <p>2</p>
--	---

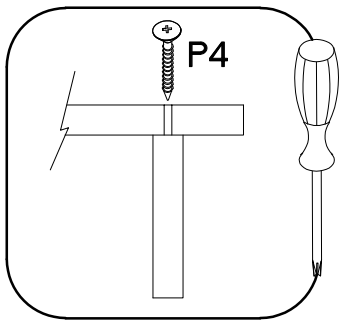
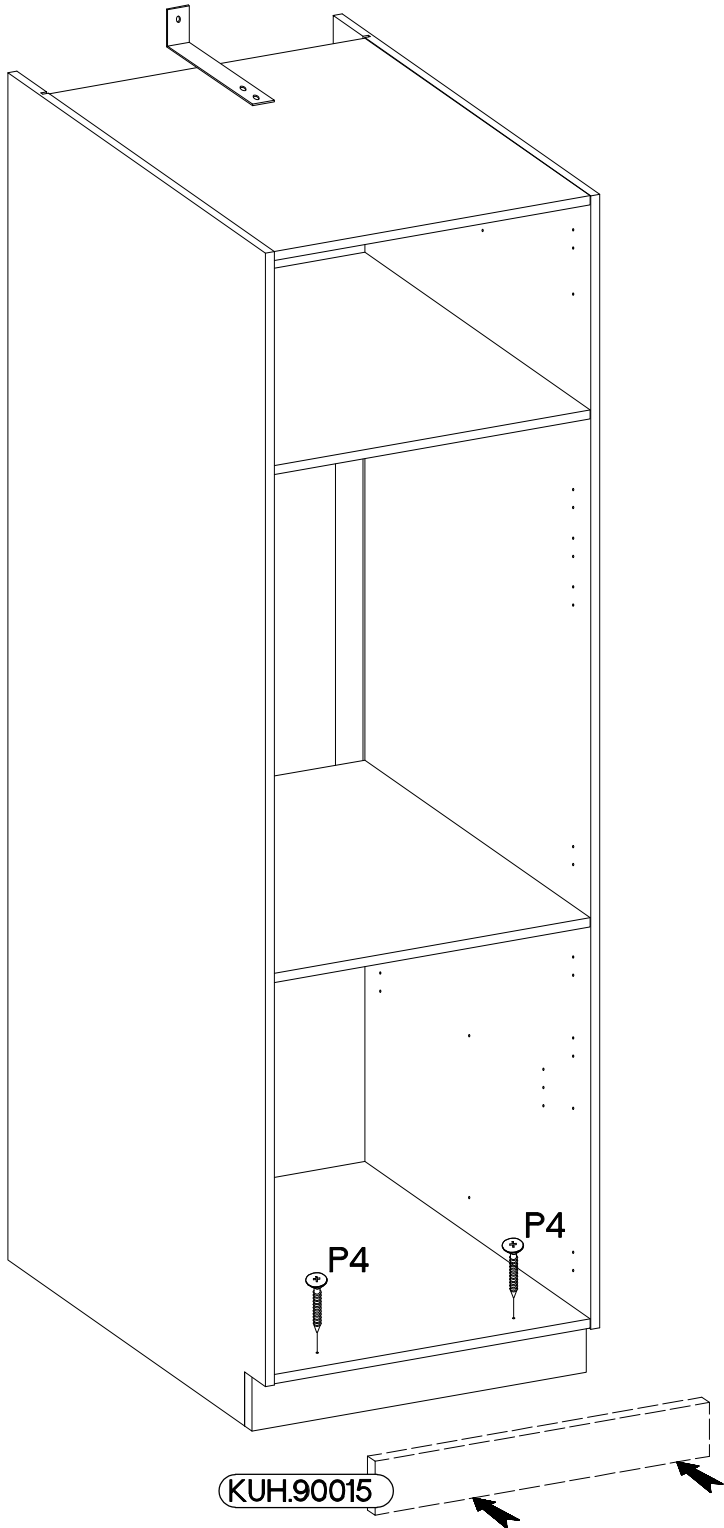

18

<p>±5/19mm</p>  <p>J</p> <p>4</p>
--

