

2X

25 MIN

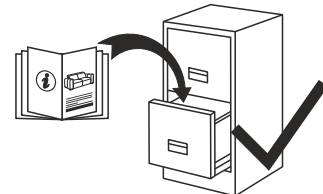
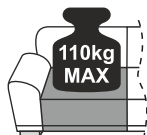

MODEL

BRUNO

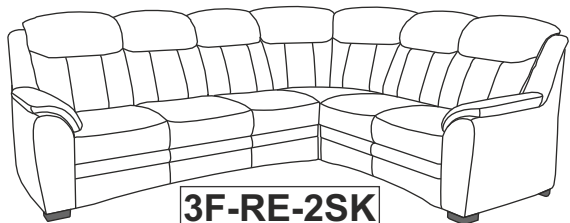

3F-RE-2SK



2SK-RE-3F

1/1

A	B	C	D	E	F H45 x5	G H45 x3
---	---	---	---	---	----------------	----------------

HARDWARE BAG / SACHET MATÉRIEL / ZUBEHÖRBEUTEL / SACCHETTI MATERIALE / BOLSA DE MATERIALES / WOREK MATERIALOWY

PRE-ASSEMBLED / PRÉ ASSEMBLÉ / VORMONTIERT / PREMONTATO / WSTĘPNIE ZAMONTOWANE

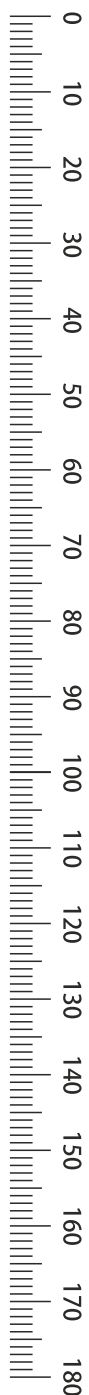

1

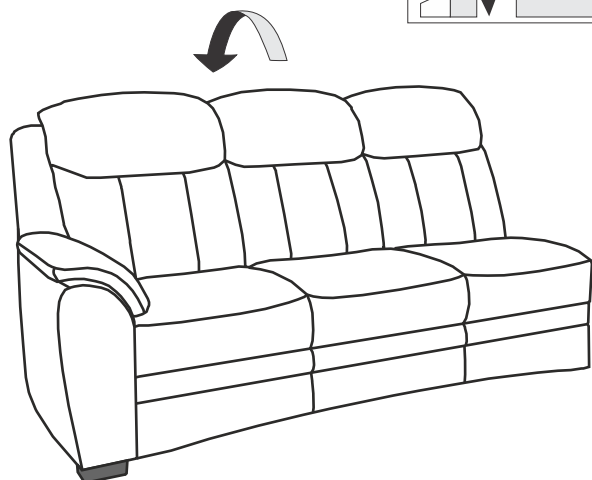

2

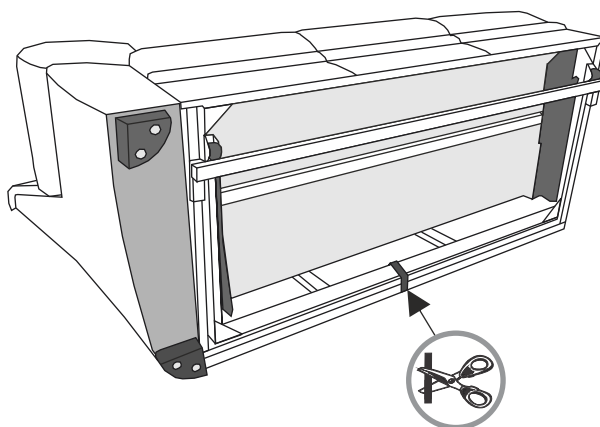

3

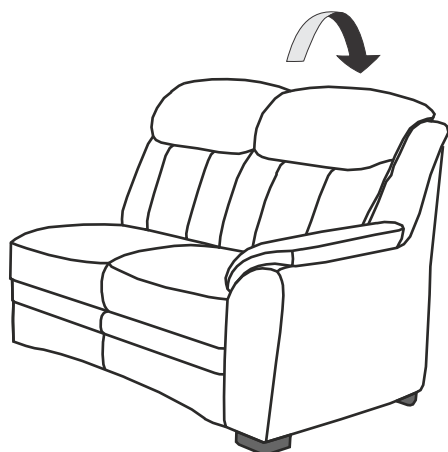

4

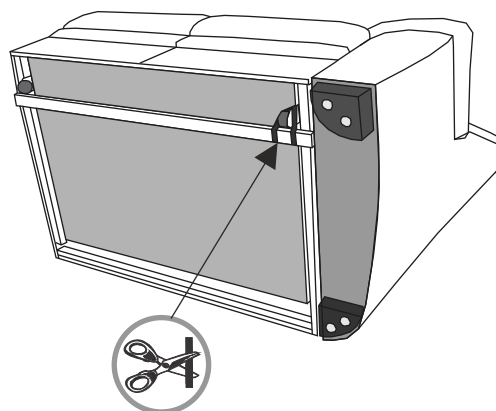

2X

25 MIN

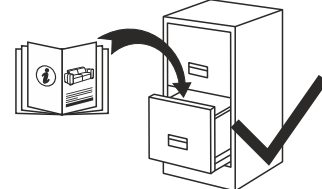
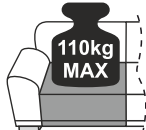

MODEL

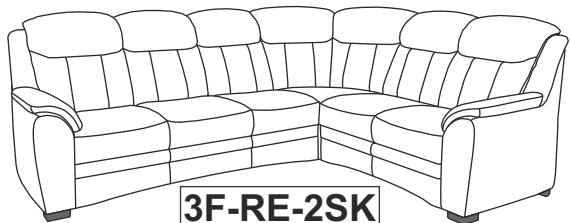

3F-RE-2SK



2SK-RE-3F

2/2

5

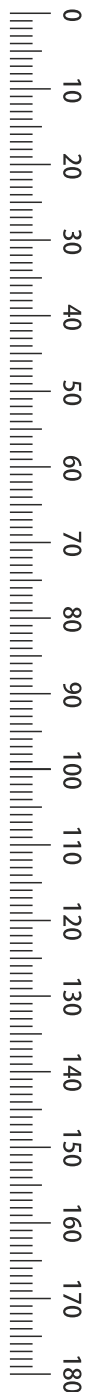
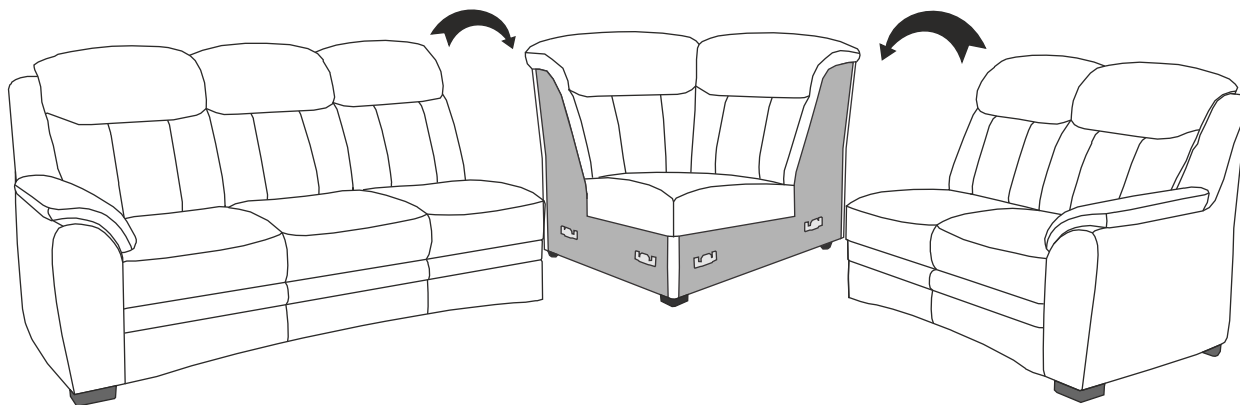

6

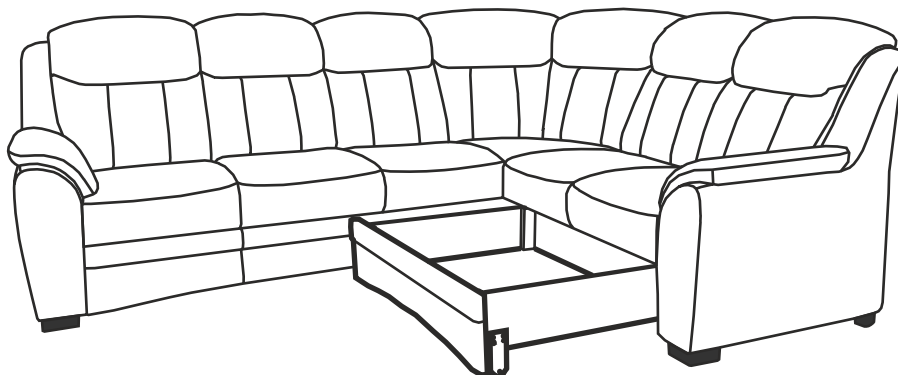

7

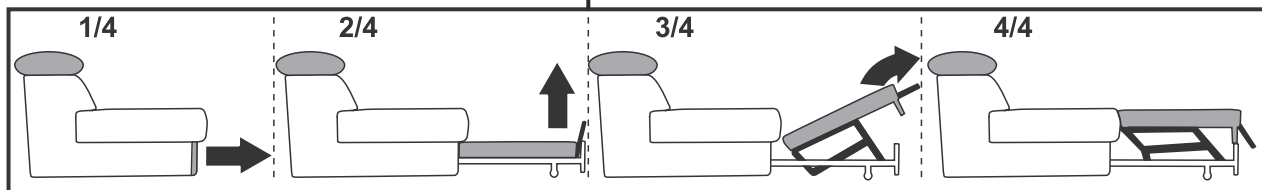
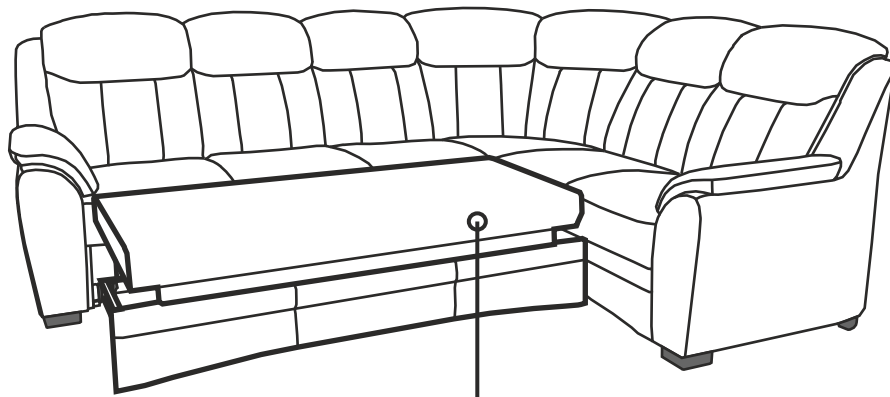

FR

Pensez à donner ou recycler.



Association



Magasin



Déchèterie



LE TRI FACILE

