

Ø 10 mm

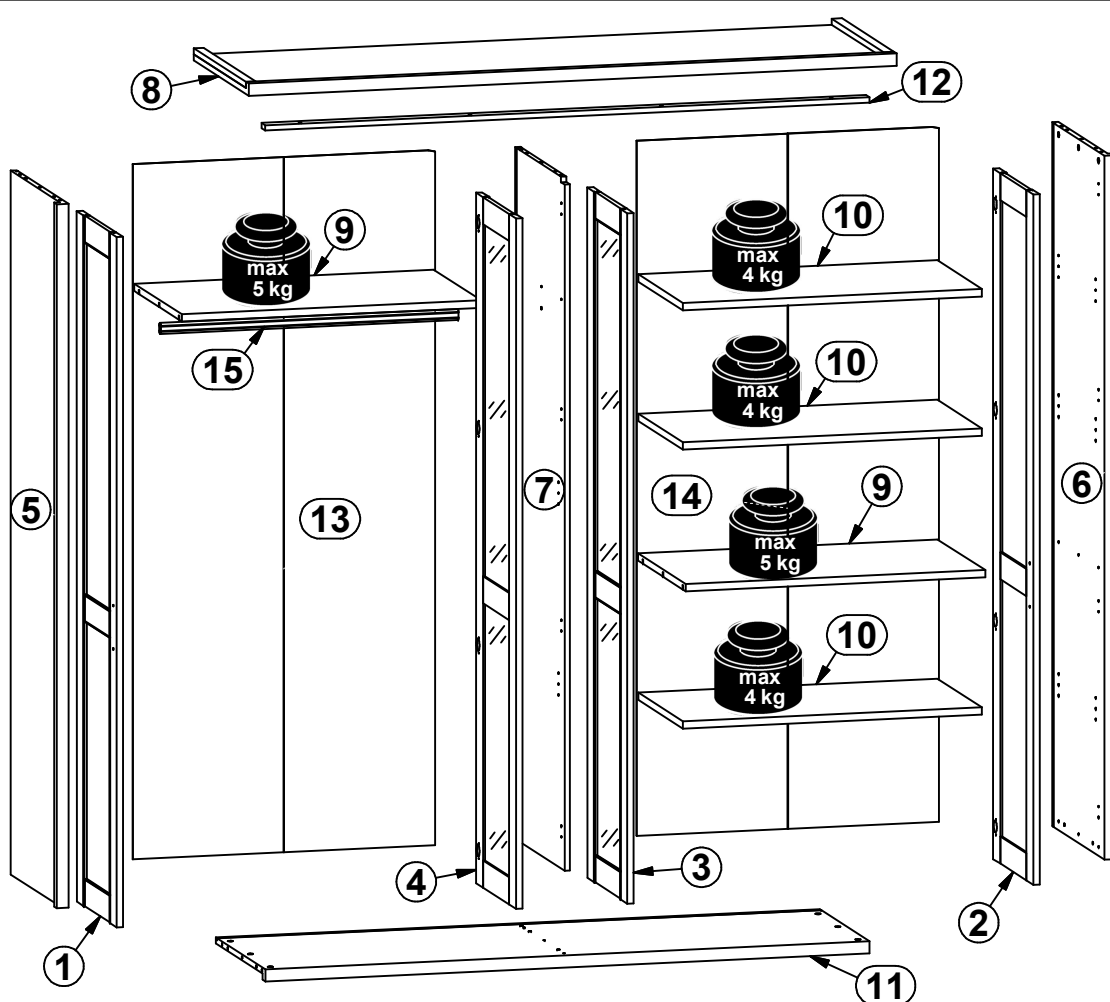

A	B	C (mm)			D
1	L30-001	2040	450	19	5/5
2	L30-002	2040	450	19	5/5
3	L30-003	2040	450	19	5/5
4	L30-046	2040	450	19	5/5
5	L30-101	2080	585	36	1/5
6	L30-135	2080	585	36	1/5
7	L30-136	2044	556	16	2/5
8	L30-208	1952	615	36	3/5
9	L30-302	902	535	22	2/5
10	L30-327	901	500	22	4/5
11	L30-328	1820	556	36	3/5
12	L30-417	1820	40	16	3/5
13	L30-901-01	2054	910	2,5	2/5
14	L30-923	2054	910	2,5	2/5
15	dr-897x30	897	30	15	4/5

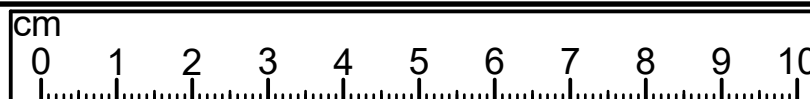

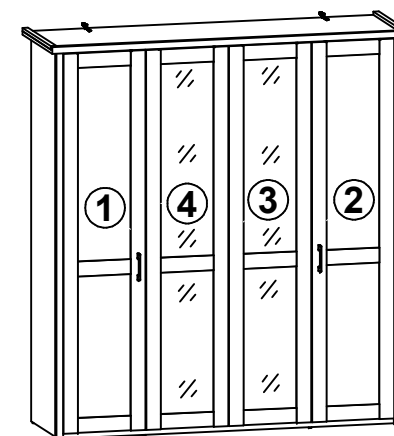
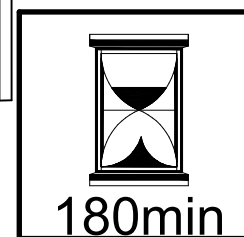

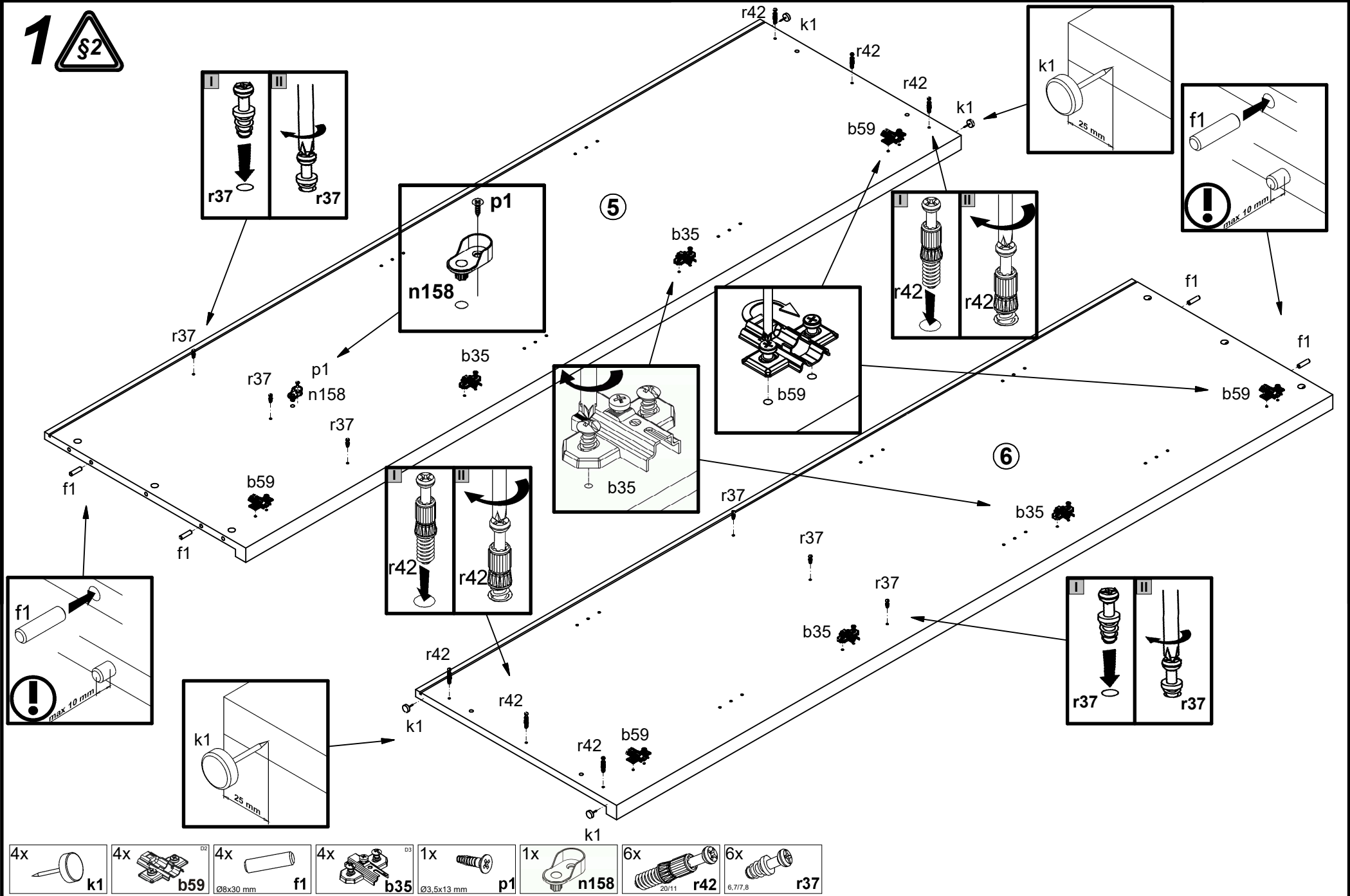



4x K16, 435 hamulec a101	4x K9, 435 hamulec a103	4x K16 a43	4x K9,5 a68	8x D3 b35	8x D2 b59	2x t28 mm c406	6x Ø5x17 mm d1	4x d20	6x d39	4x Ø6,3x13 mm e2	4x Ø7x28 mm e22	12x Ø8x30 mm f1
2x Ø10x50 mm f35	4x M4x25 mm j8	6x k1	1x M6/Ø14x14 mm k39/2	1x M6/22 mm k39/3	44x l2	2x 86x21x15/1,5 n14/2	2x n158	2x Ø3,5x13 mm p1	6x Ø2,5x13 mm p15	2x Ø5x60 mm p17	4x Ø3,5x16 mm p38	32x Ø3,5x15 mm p51
18x Ø15x12 mm #16 r1	12x Ø20x12 mm #16 r36	12x 6,7/7,8 r37	18x 20/11 r42	4x s1	18x Ø16 s2	1x 4 mm z1						

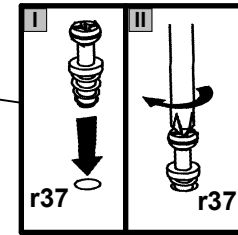
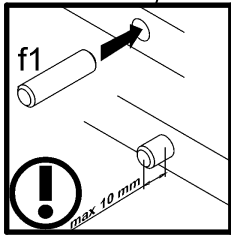
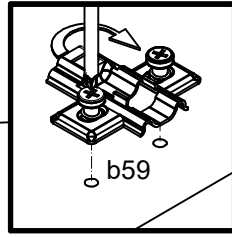
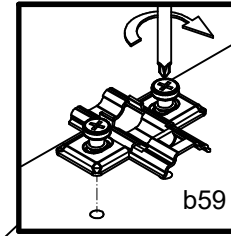
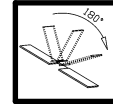
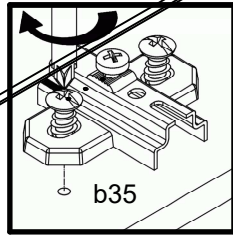
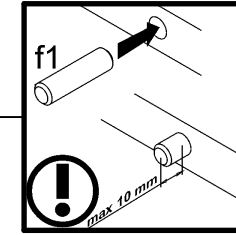
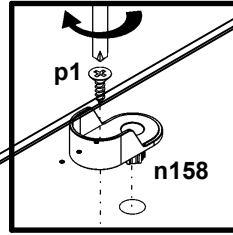
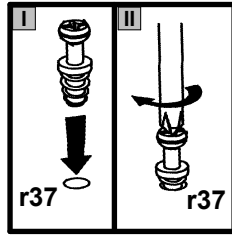

- | | | | | | | | |
|----|----|----------|----|------------|----|-------|---------|
| 4x | 4x | 4x | 4x | 1x | 1x | 6x | 6x |
| | | | | | | | |
| | | Ø8x30 mm | | Ø3,5x13 mm | | 20/11 | 6,7/7,8 |

2 



- 4x  **b59**
- 4x  **b35**
- 4x  **f1**
- 1x  **n158**
- 1x  **p1**
- 6x  **r37**

3 §2

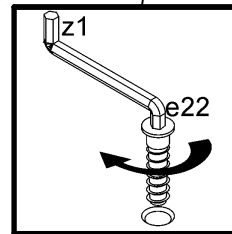
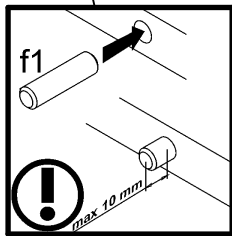
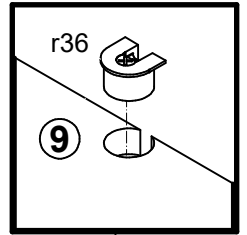
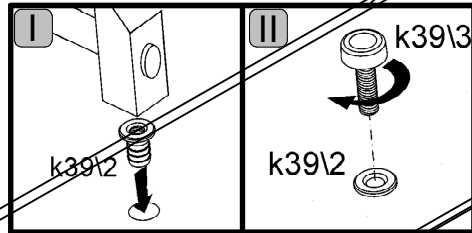
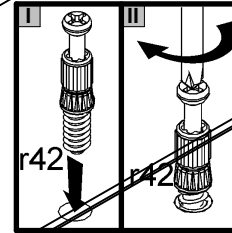
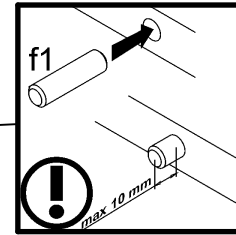
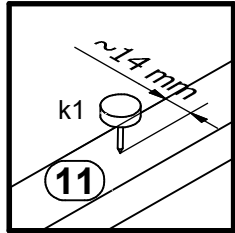
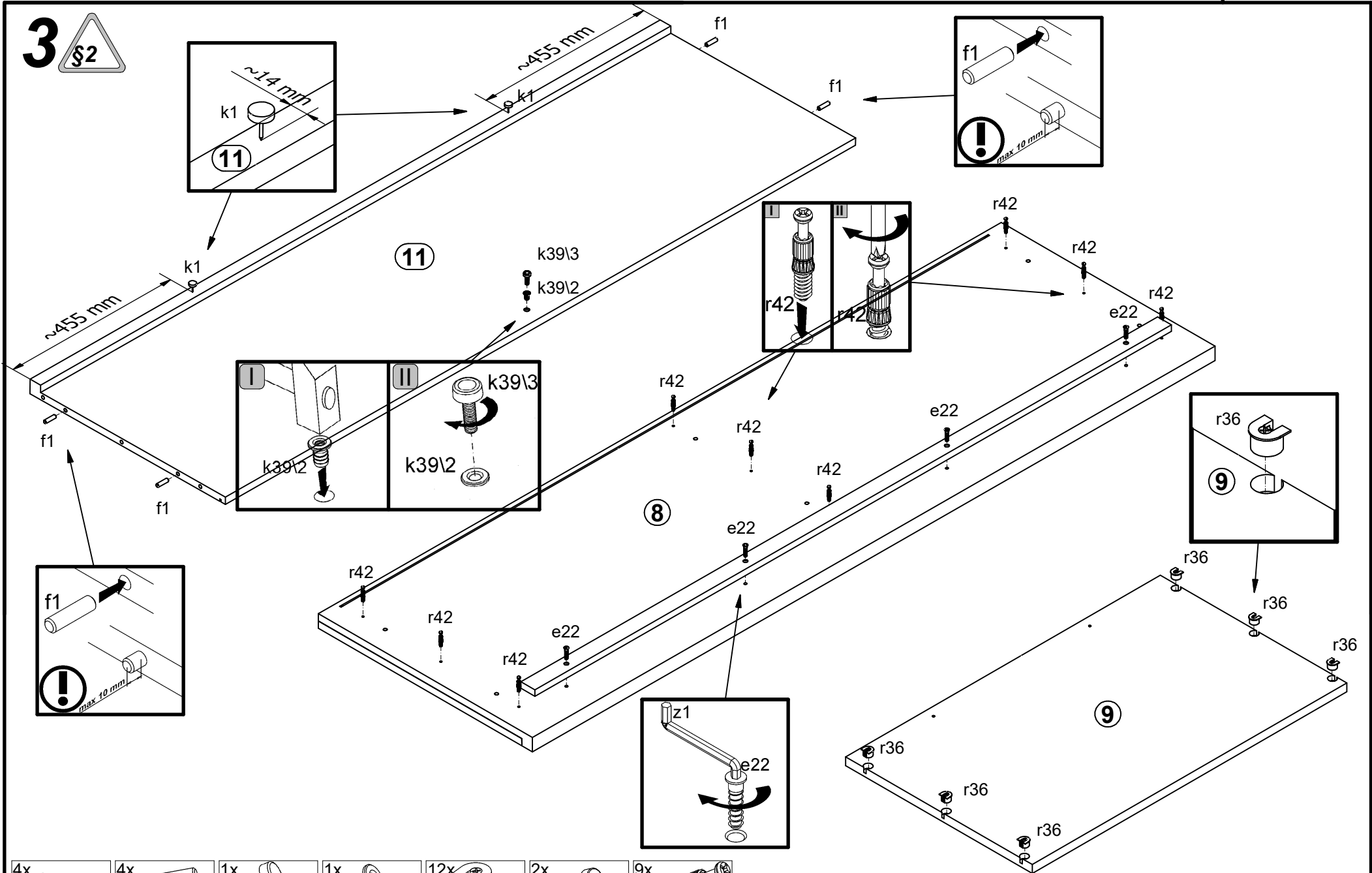

- 4x  e22 Ø7x28 mm
- 4x  f1 Ø8x30 mm
- 1x  k39/3 M6/22 mm
- 1x  k39/2 M6/Ø14x14 mm
- 12x  r36 Ø20x12 mm #16
- 2x  k1
- 9x  r42 20/11

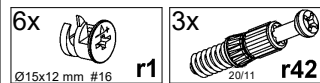
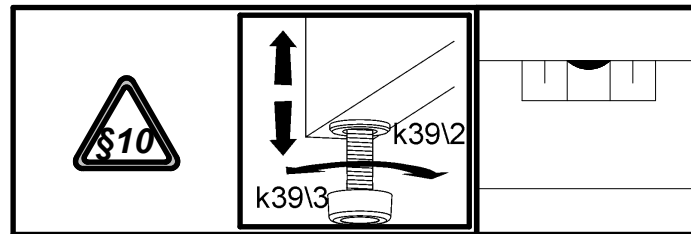
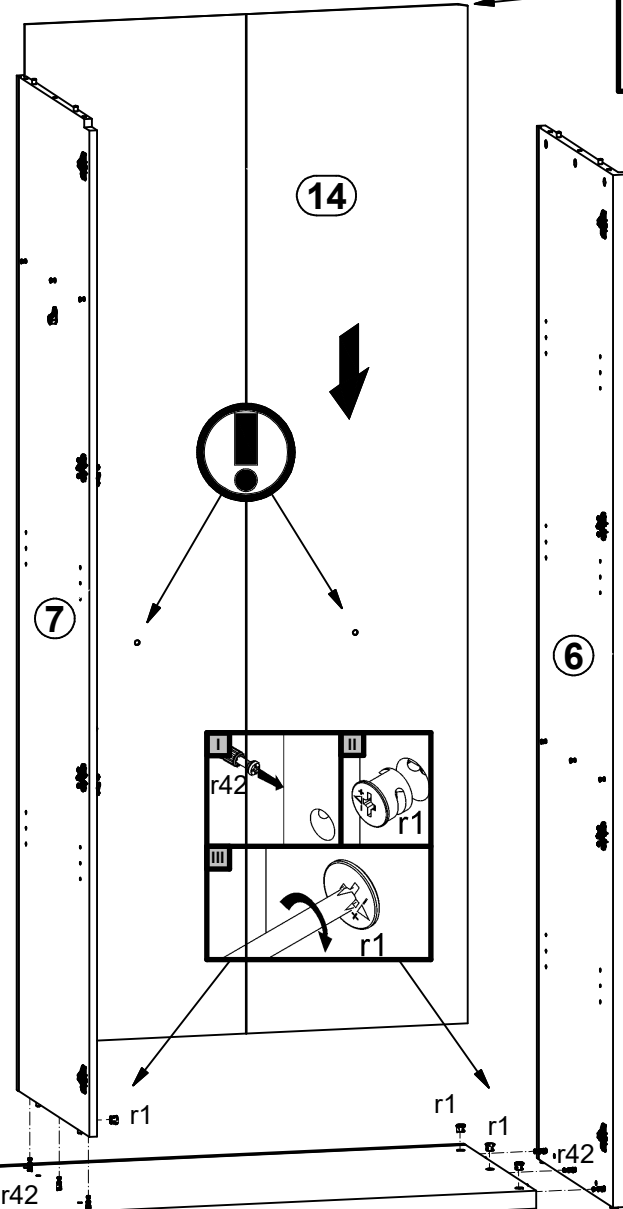
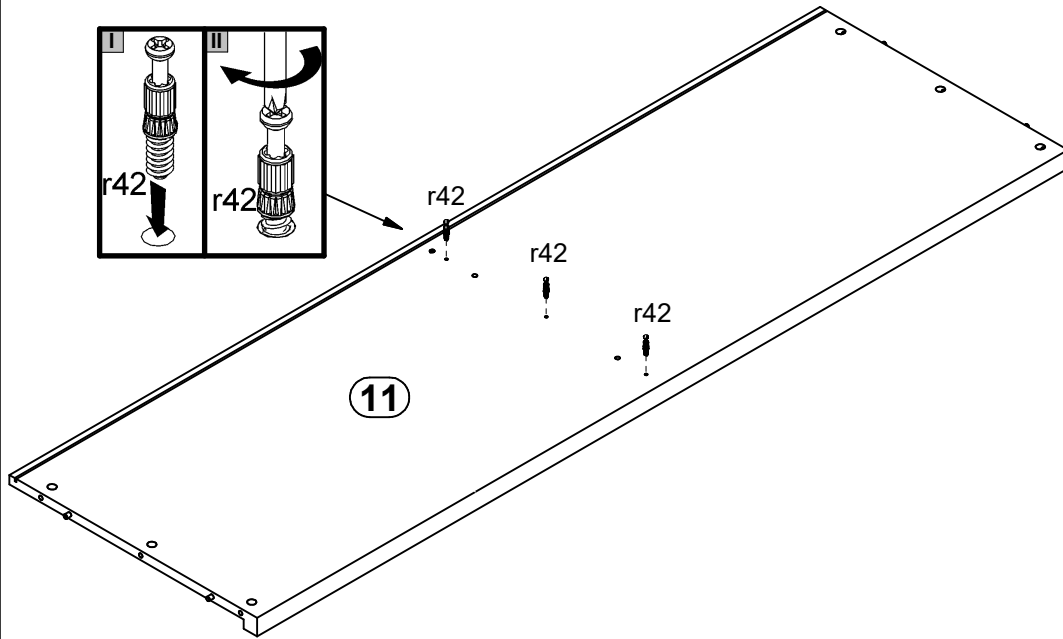
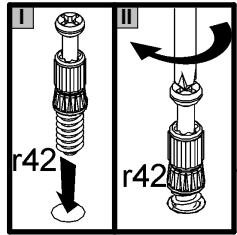
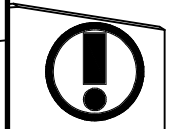

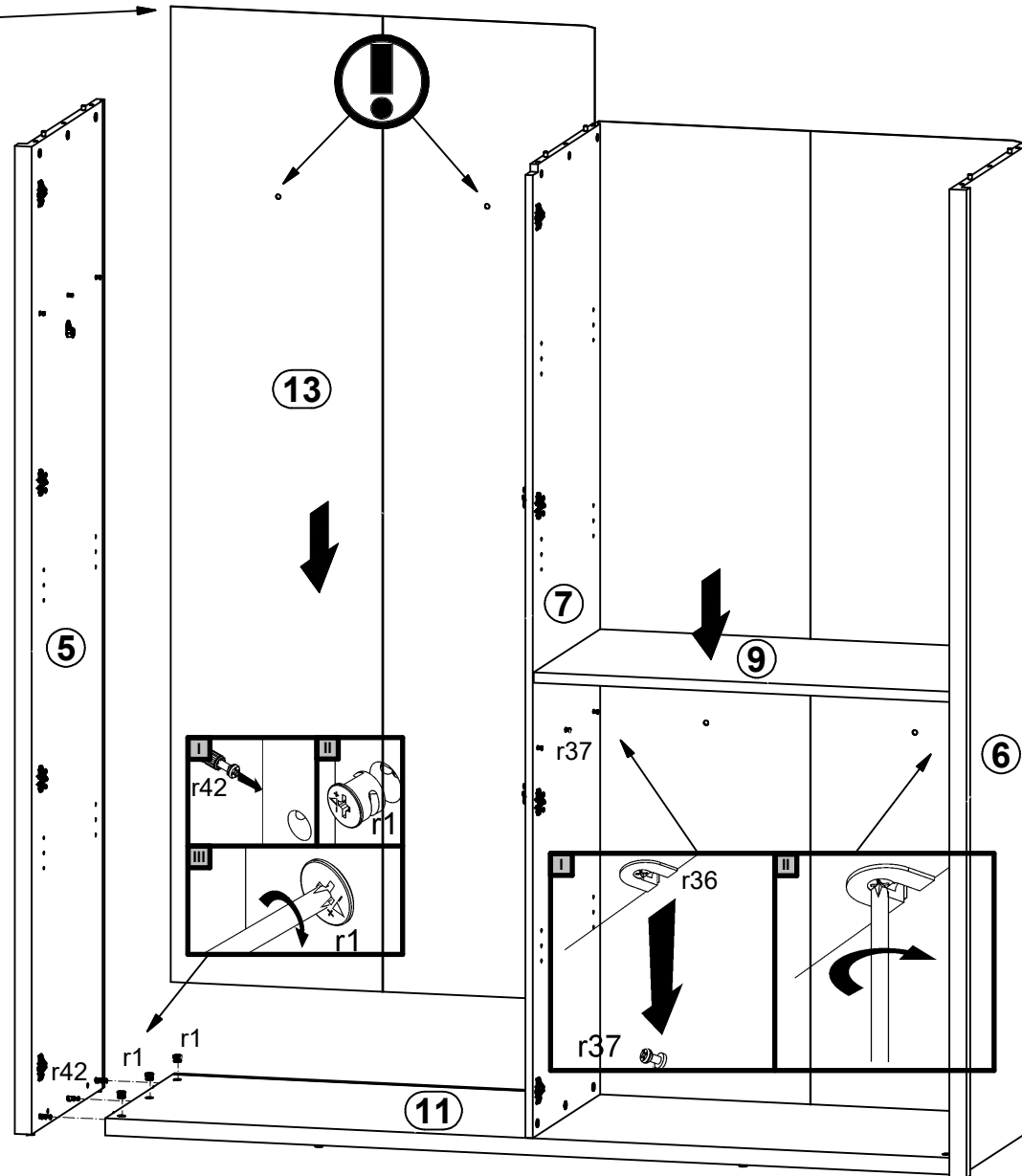
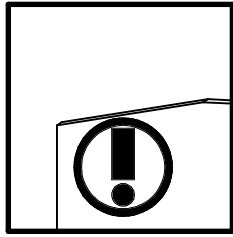

5  §6

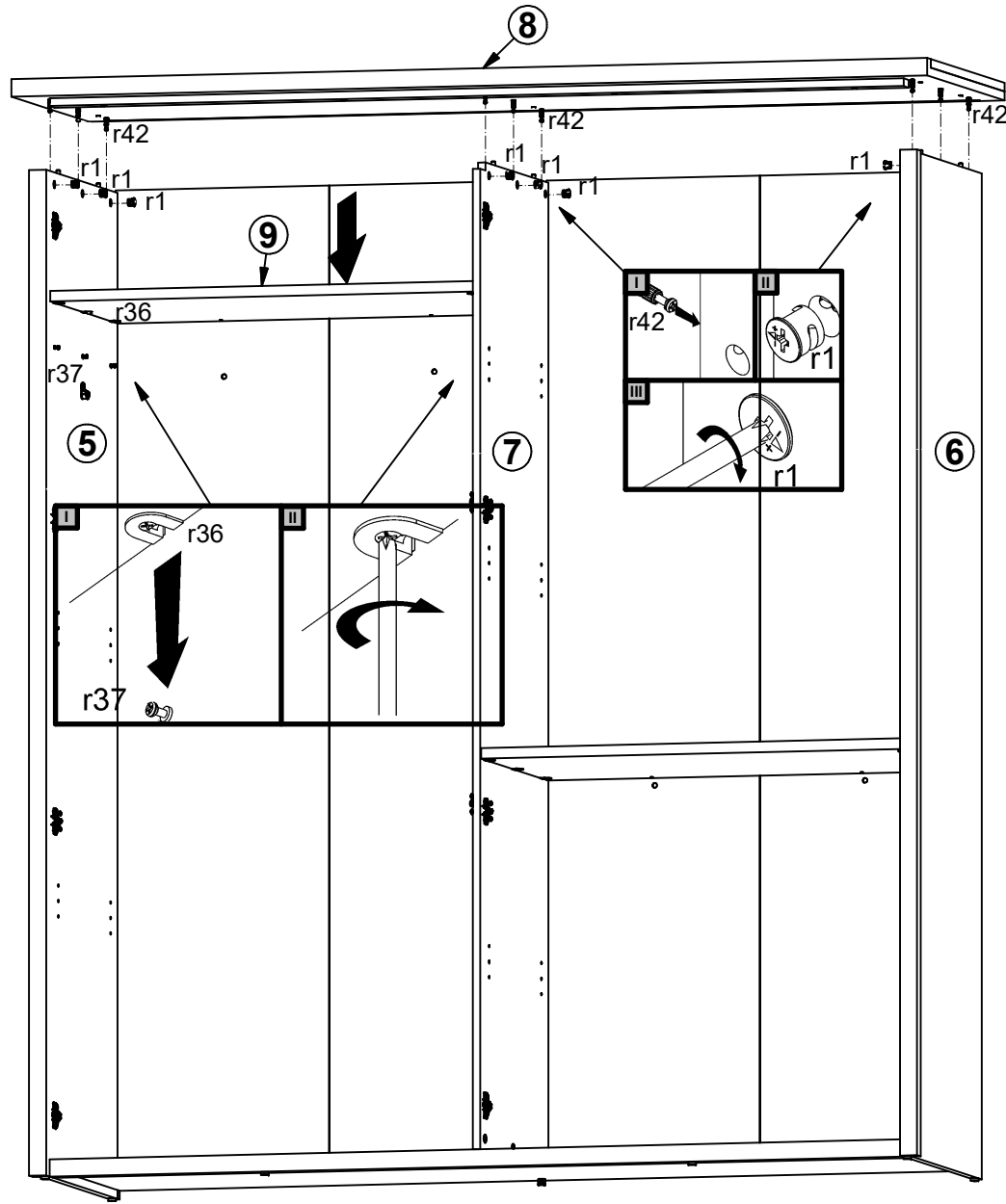

3x  r1
Ø15x12 mm #16

6 §6



9x  r1
Ø15x12 mm #16

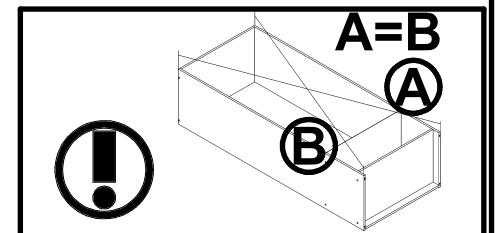
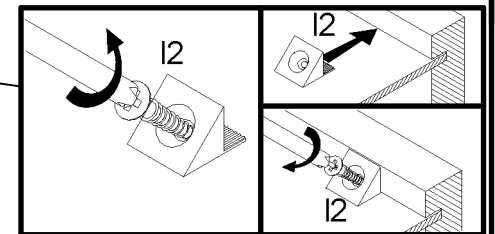
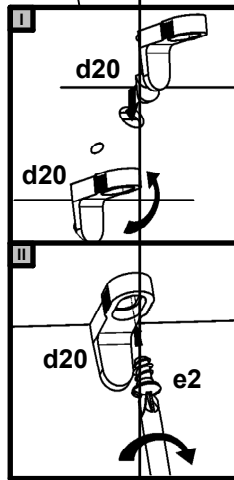
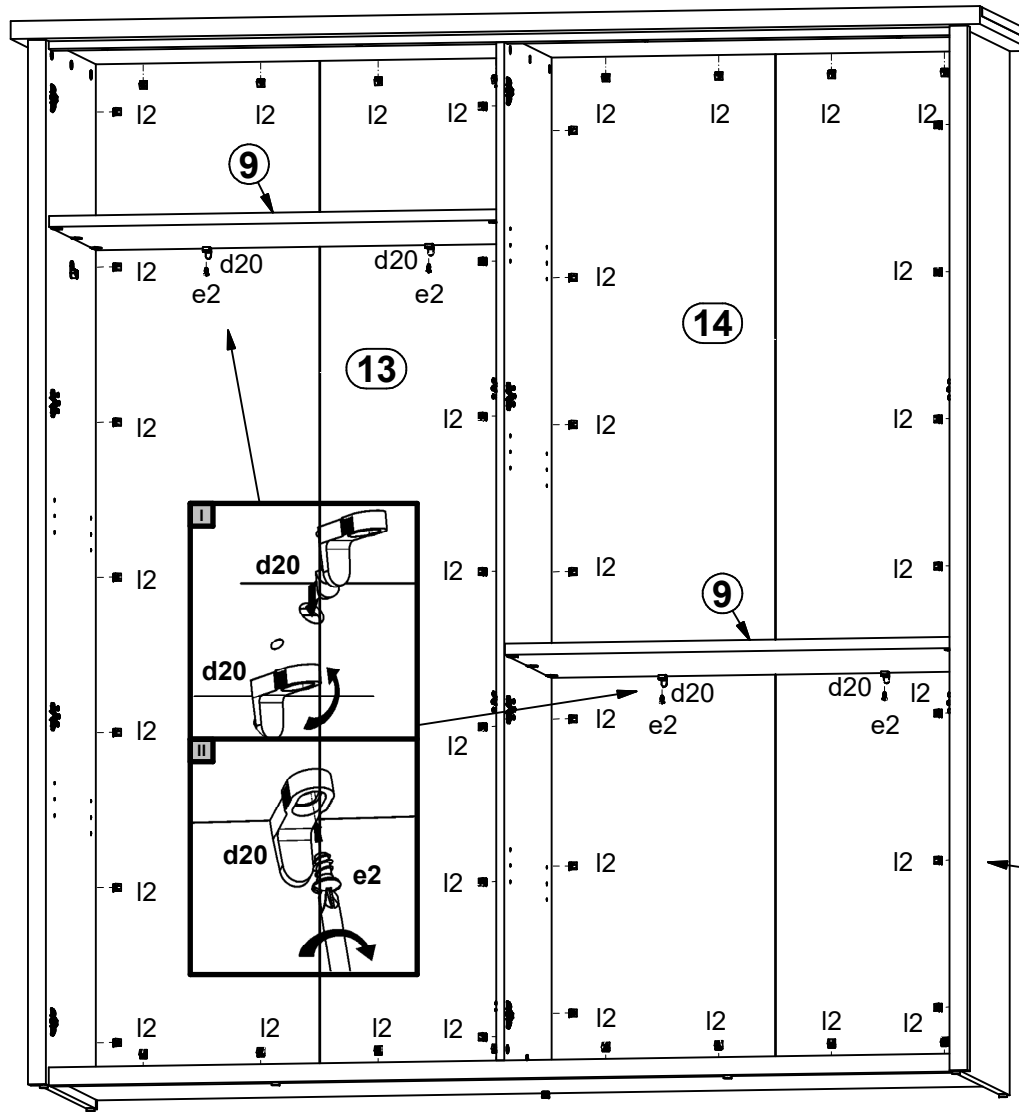

7 §6

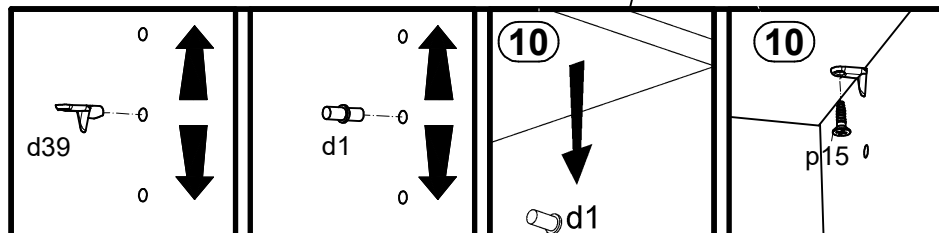
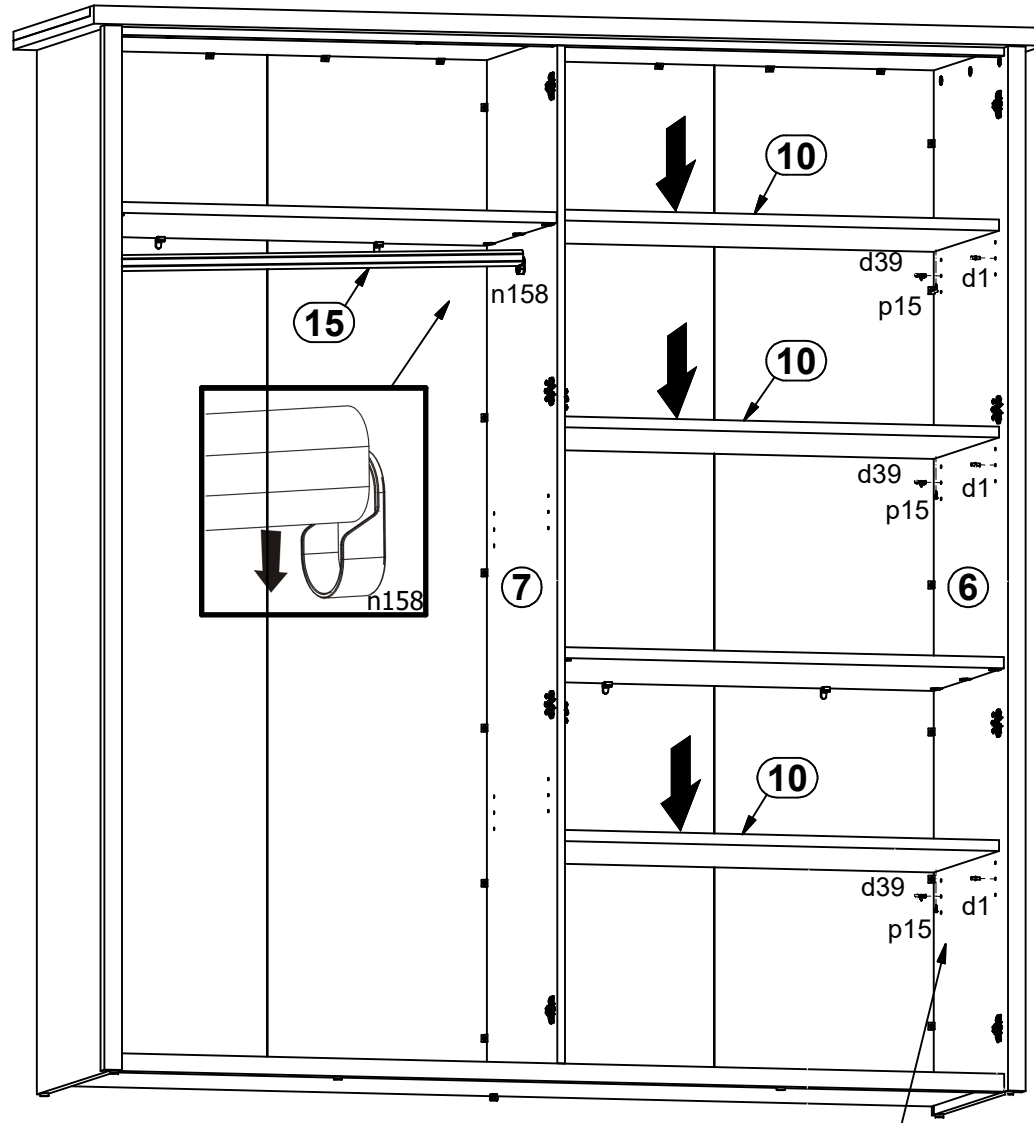

- 4x d20
- 4x Ø6,3x13 mm e2
- 44x I2

8 







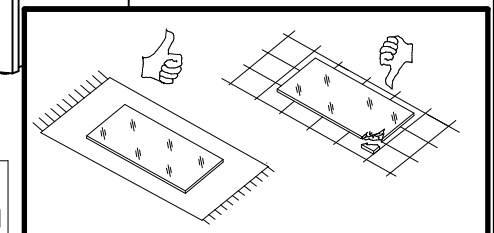
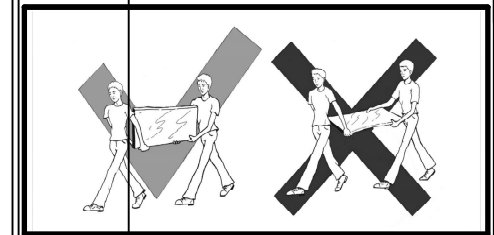
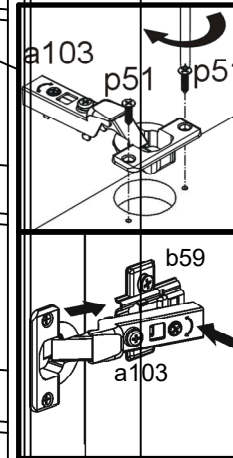
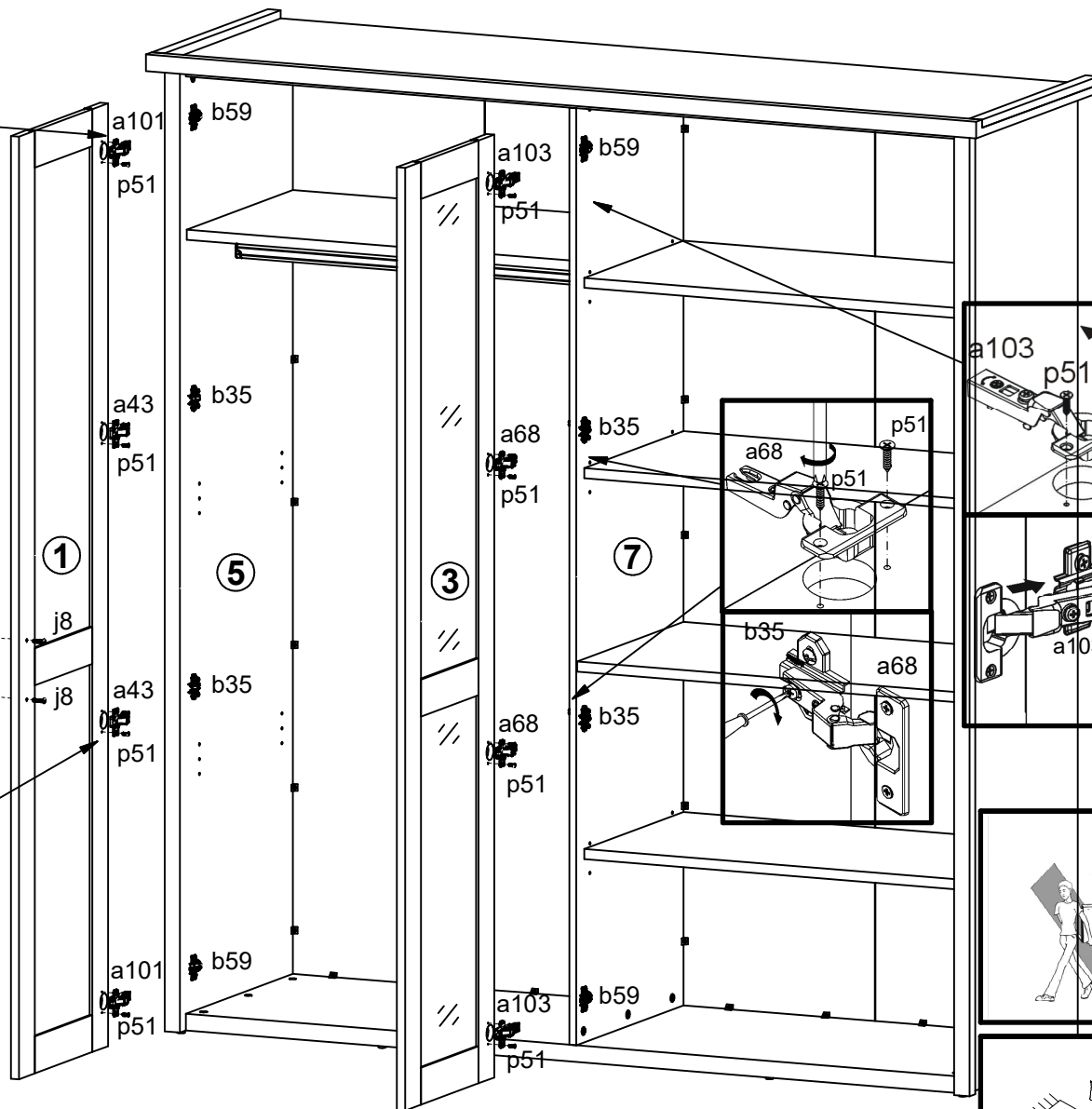
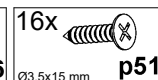
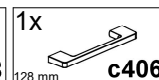
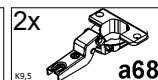
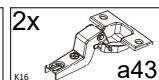
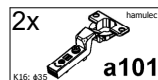
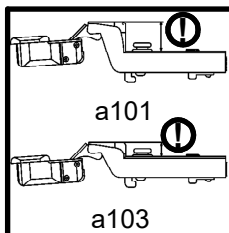
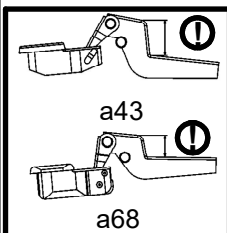
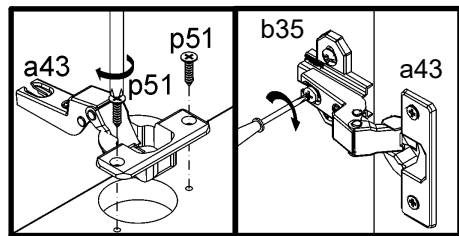
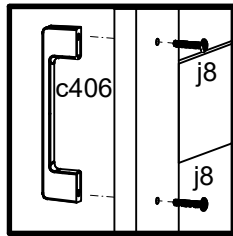
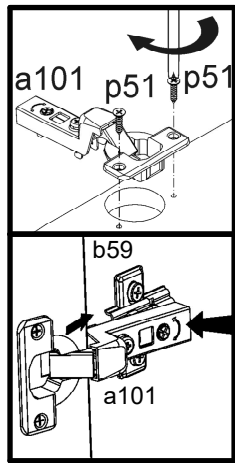

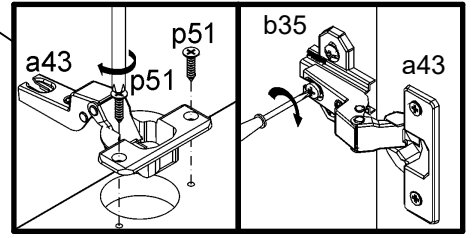
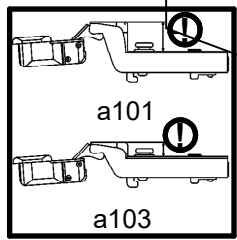
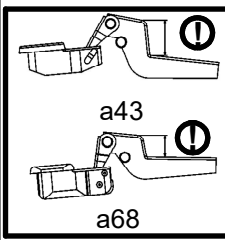
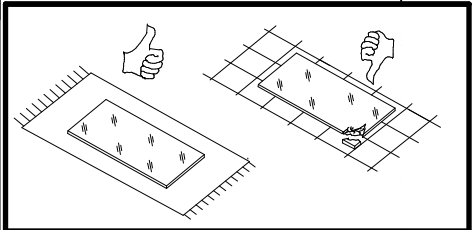
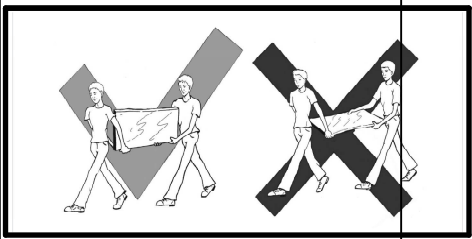
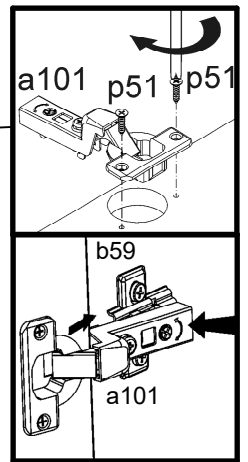
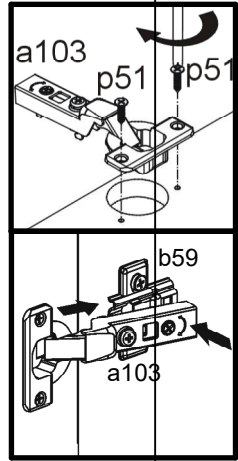
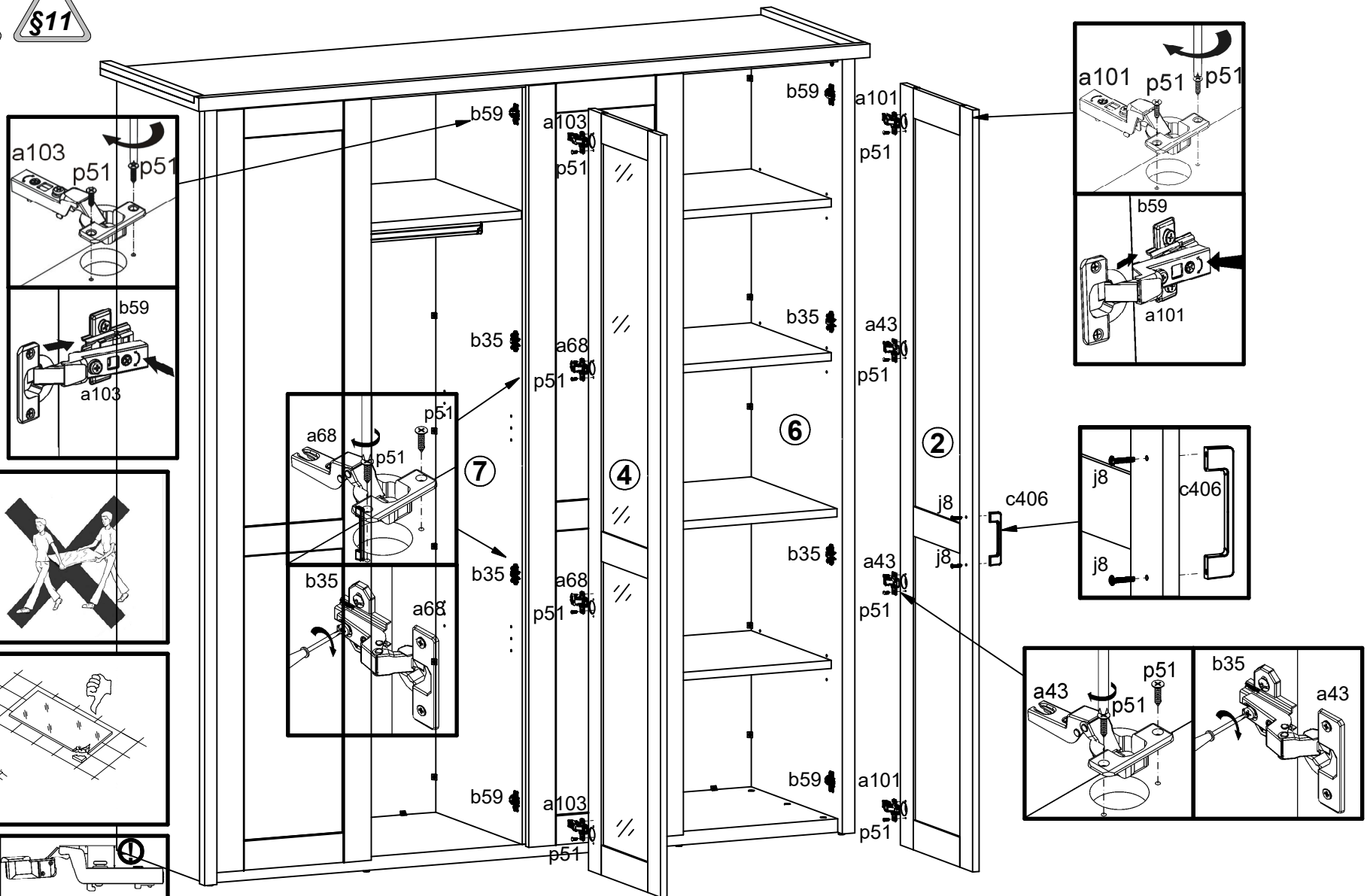

- 6x  d1
- 6x  d39
- 6x  p15

9

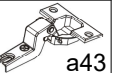

10  



- 2x  hamulec
a101
K16; Ø35
- 2x  **j8**
M4x25 mm
- 2x  hamulec
a103
K9; Ø35
- 2x  **a43**
K16
- 2x  **a68**
K9,5
- 1x  **c406**
l128 mm
- 16x  **p51**
Ø3,5x15 mm

11 §4

